

VOLEKTRA 2400

o **PRODUCT CATEGORY**
BUILT-INS

o **PRODUCT CODE**
VOLEKTRA2400HER



evonicfires.co.uk/built-ins-volektra/



PRODUCT SPECIFICATION

FLAME TYPE	ROTISSERIE
HEIGHT (A)	590mm
WIDTH (B)	2443mm
DEPTH (C)	300mm
GLASS TYPE	UHD ANTI-REFLECTIVE
LOG TYPE	HERITAGE
CONTROL METHOD	E-SMART PLUS APP OR BLACK REMOTE



PRODUCT SPECIFICATION		PRODUCT SPECIFICATION	
FLAME EFFECT	VOLEKTRA	LAUNCH DATE	TBC
FLAME COLOUR	1 FLAME COLOUR	BRAND	EVONIC
LOG SET	HERITAGE	PRODUCT CATEGORY	BUILT-IN
ENGINE FLAME	VOLEKTRA	MODEL	VOLEKTRA 2400
FUEL TYPE	ELECTRIC	COUNTRY OF ORIGIN	CHINA
CONTROLS	APP & REMOTE	UKCA	YES
E-SMART	YES	NICA	YES
APP TECHNOLOGY	YES	CE (EUROPE)	YES
HEAT OUTPUT	1500W	LOT 20	YES
HEAT SETTINGS	VARIABLE	WEEE	YES
VARIABLE THERMOSTAT	YES	PACKAGING	
LAMP STYLE	LED	BOX HEIGHT	800mm
POWER CORD	1.8M KETTLE	BOX WIDTH	2720mm
SAFETY CUT-OUT	YES	BOX DEPTH	420mm
CORE MATERIAL	STEEL	PALLET WIDTH	2750mm
ACCESSORIES		PALLET DEPTH	440mm
		UNITS PER PALLET	1 (Unique Pallet)
		WEIGHT	150kg

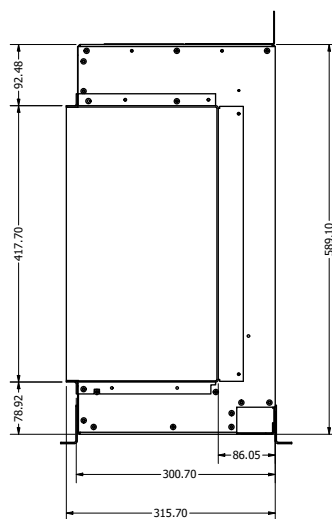
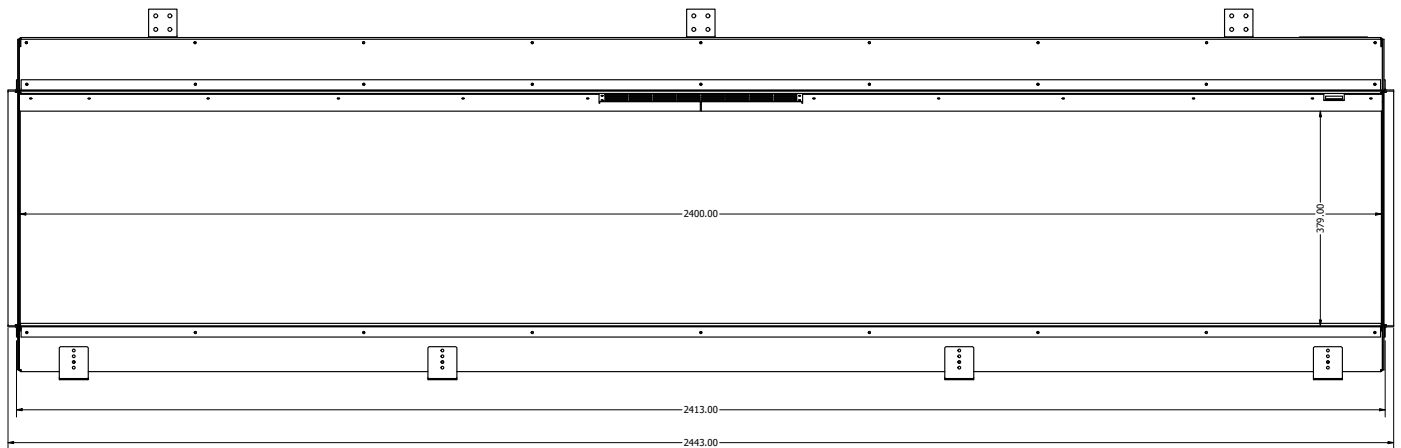
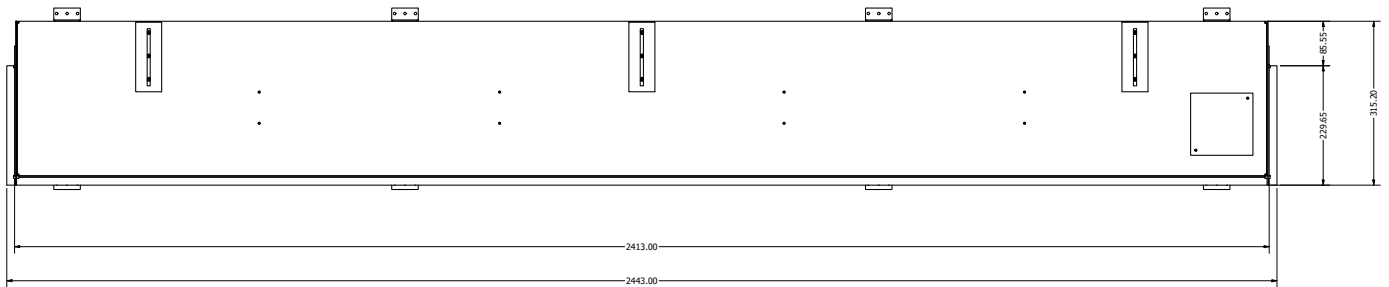

VOLEKTRA 2100



o **PRODUCT CATEGORY**
BUILT-INS

o **PRODUCT CODE**
VOLEKTRA2100HER



evonicfires.co.uk/built-ins-volektra/

PRODUCT SPECIFICATION

FLAME TYPE	ROTISSERIE
HEIGHT (A)	590mm
WIDTH (B)	2145mm
DEPTH (C)	300mm
GLASS TYPE	UHD ANTI-REFLECTIVE
LOG TYPE	HERITAGE
CONTROL METHOD	E-SMART PLUS APP OR BLACK REMOTE



PRODUCT SPECIFICATION		PRODUCT SPECIFICATION	
FLAME EFFECT	VOLEKTRA	LAUNCH DATE	TBC
FLAME COLOUR	1 FLAME COLOUR	BRAND	EVONIC
LOG SET	HERITAGE	PRODUCT CATEGORY	BUILT-IN
ENGINE FLAME	VOLEKTRA	MODEL	VOLEKTRA 2100
FUEL TYPE	ELECTRIC	COUNTRY OF ORIGIN	CHINA
CONTROLS	APP & REMOTE	UKCA	YES
E-SMART	YES	NICA	YES
APP TECHNOLOGY	YES	CE (EUROPE)	YES
HEAT OUTPUT	1500W	LOT 20	YES
HEAT SETTINGS	VARIABLE	WEEE	YES
VARIABLE THERMOSTAT	YES	PACKAGING	
LAMP STYLE	LED	BOX HEIGHT	800mm
POWER CORD	1.8M KETTLE	BOX WIDTH	2720mm
SAFETY CUT-OUT	YES	BOX DEPTH	420mm
CORE MATERIAL	STEEL	PALLET WIDTH	2750mm
ACCESSORIES		PALLET DEPTH	440mm
		UNITS PER PALLET	1 (Unique Pallet)
		WEIGHT	130kg

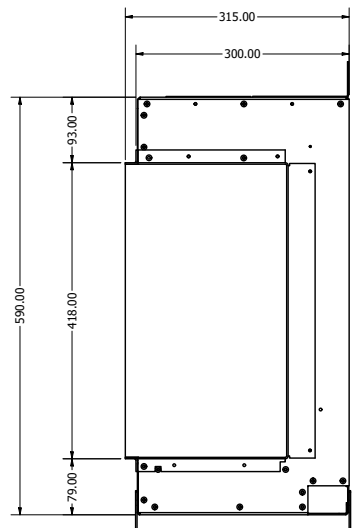
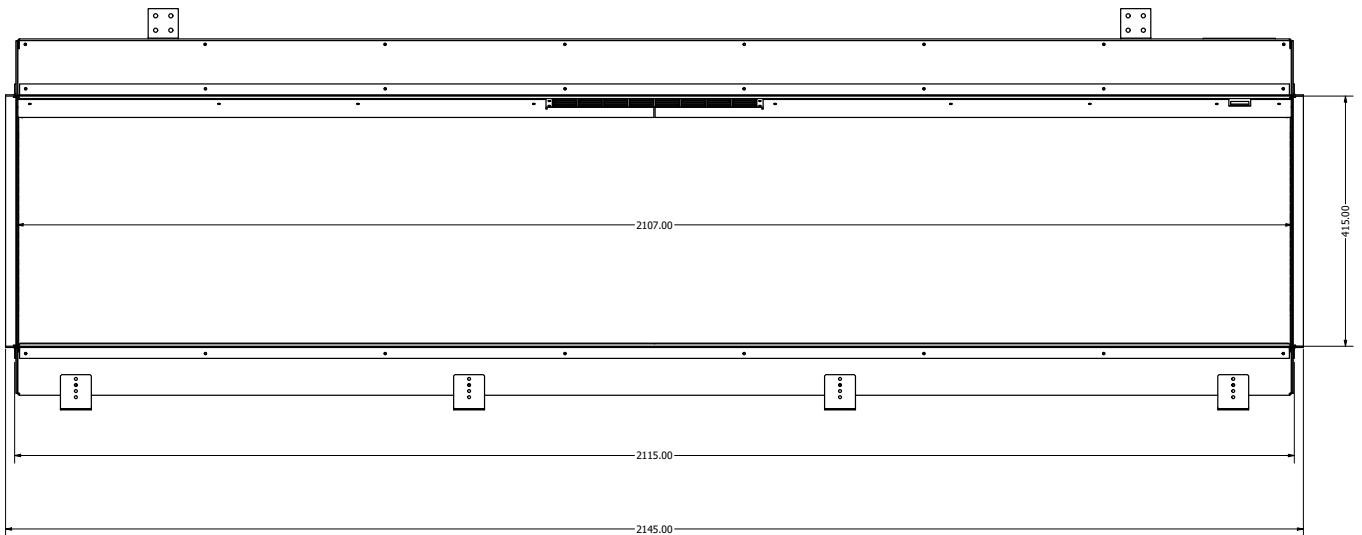
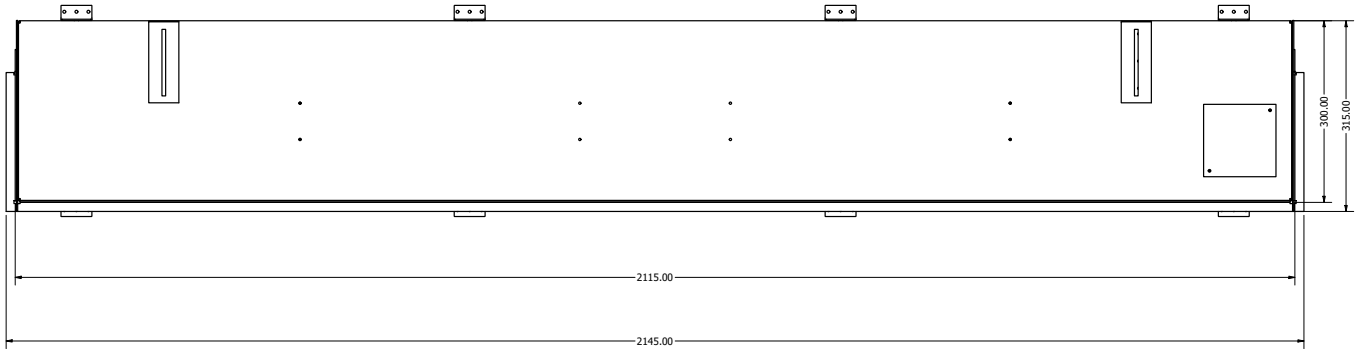

VOLEKTRA 1800

o **PRODUCT CATEGORY**
BUILT-INS

o **PRODUCT CODE**
VOLEKTRA1800HER



evonicfires.co.uk/built-ins-volektra/



PRODUCT SPECIFICATION

FLAME TYPE	ROTISSERIE
HEIGHT (A)	587mm
WIDTH (B)	1785mm
DEPTH (C)	300mm
GLASS TYPE	UHD ANTI-REFLECTIVE
LOG TYPE	HERITAGE
CONTROL METHOD	E-SMART PLUS APP OR BLACK REMOTE



PRODUCT SPECIFICATION		PRODUCT SPECIFICATION	
FLAME EFFECT	VOLEKTRA	LAUNCH DATE	TBC
FLAME COLOUR	1 FLAME COLOUR	BRAND	EVONIC
LOG SET	HERITAGE	PRODUCT CATEGORY	BUILT-IN
ENGINE FLAME	VOLEKTRA	MODEL	VOLEKTRA 1800
FUEL TYPE	ELECTRIC	COUNTRY OF ORIGIN	CHINA
CONTROLS	APP & REMOTE	UKCA	YES
E-SMART	YES	NICA	YES
APP TECHNOLOGY	YES	CE (EUROPE)	YES
HEAT OUTPUT	1500W	LOT 20	YES
HEAT SETTINGS	VARIABLE	WEEE	YES
VARIABLE THERMOSTAT	YES	PACKAGING	
LAMP STYLE	LED	BOX HEIGHT	810mm
POWER CORD	1.8M KETTLE	BOX WIDTH	2120mm
SAFETY CUT-OUT	YES	BOX DEPTH	410mm
CORE MATERIAL	STEEL	PALLET WIDTH	2140mm
ACCESSORIES		PALLET DEPTH	440mm
		UNITS PER PALLET	1 (Unique Pallet)
		WEIGHT	70kg

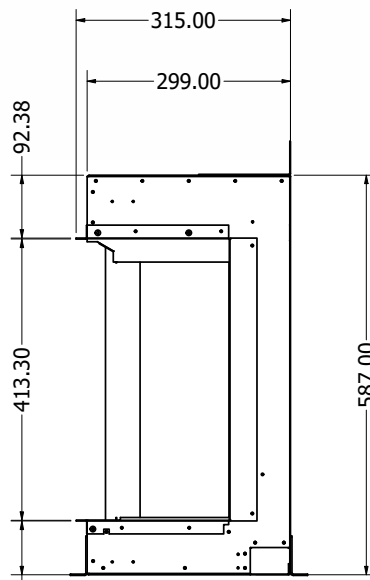
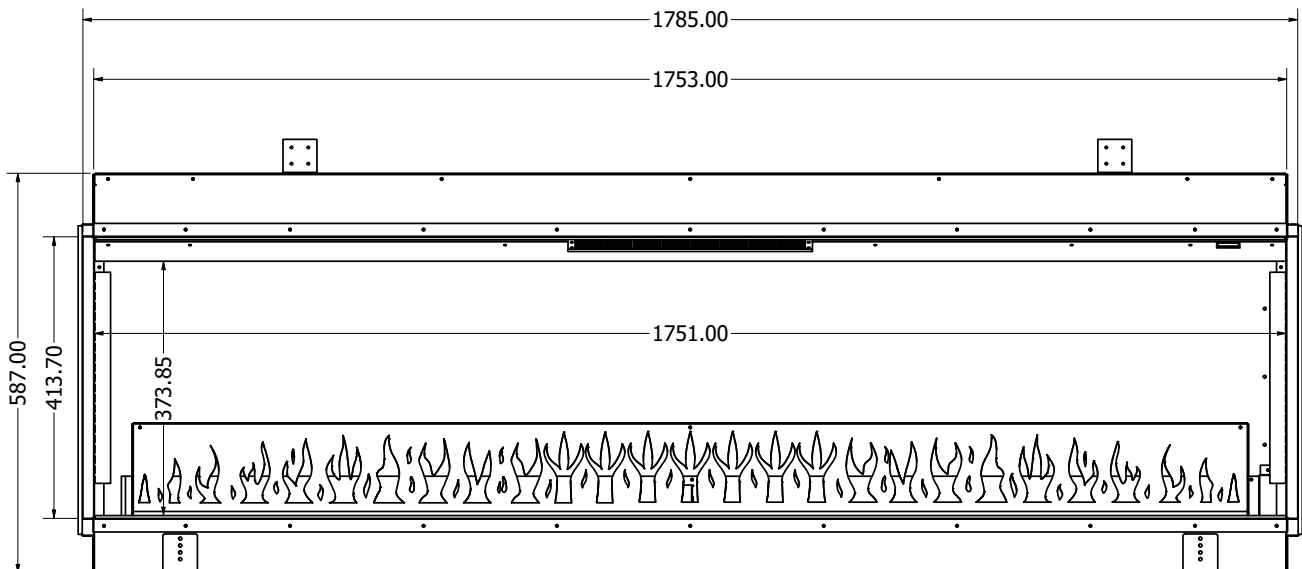
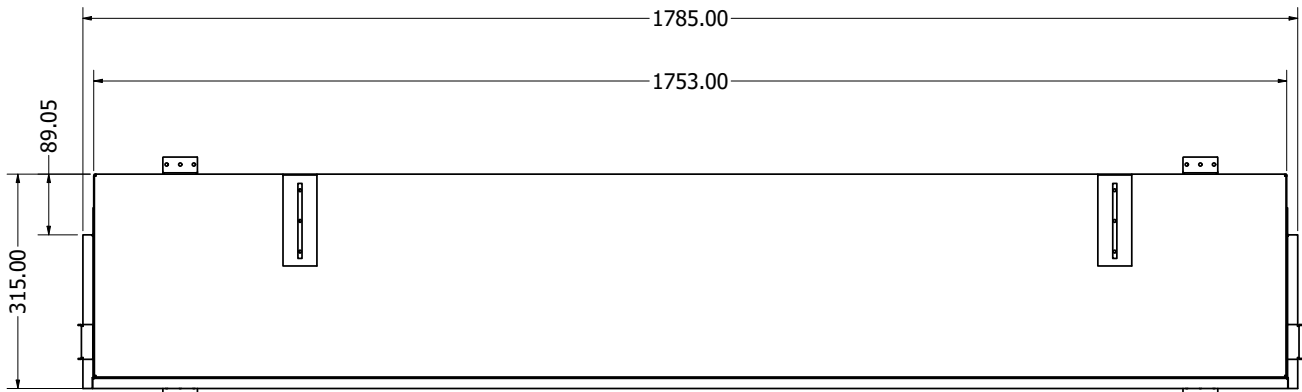

VOLEKTRA 1560

o **PRODUCT CATEGORY**
BUILT-INS

o **PRODUCT CODE**
VOLEKTRA1560HER



evonicfires.co.uk/built-ins-volektra/



PRODUCT SPECIFICATION

FLAME TYPE	ROTISSERIE
HEIGHT (A)	808mm
WIDTH (B)	1538mm
DEPTH (C)	300mm
GLASS TYPE	UHD ANTI-REFLECTIVE
LOG TYPE	HERITAGE
CONTROL METHOD	E-SMART PLUS APP OR BLACK REMOTE



PRODUCT SPECIFICATION		PRODUCT SPECIFICATION	
FLAME EFFECT	VOLEKTRA	LAUNCH DATE	TBC
FLAME COLOUR	1 FLAME COLOUR	BRAND	EVONIC
LOG SET	HERITAGE	PRODUCT CATEGORY	BUILT-IN
ENGINE FLAME	VOLEKTRA	MODEL	VOLEKTRA 1560
FUEL TYPE	ELECTRIC	COUNTRY OF ORIGIN	CHINA
CONTROLS	APP & REMOTE	UKCA	YES
E-SMART	YES	NICA	YES
APP TECHNOLOGY	YES	CE (EUROPE)	YES
HEAT OUTPUT	1500W	LOT 20	YES
HEAT SETTINGS	VARIABLE	WEEE	YES
VARIABLE THERMOSTAT	YES	PACKAGING	
LAMP STYLE	LED	BOX HEIGHT	860mm
POWER CORD	1.8M KETTLE	BOX WIDTH	1700mm
SAFETY CUT-OUT	YES	BOX DEPTH	450mm
CORE MATERIAL	STEEL	PALLET WIDTH	1700mm
ACCESSORIES		PALLET DEPTH	440mm
		UNITS PER PALLET	1 (Unique Pallet)
		WEIGHT	85kg

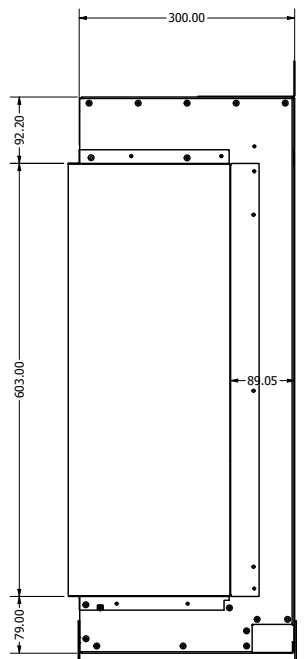
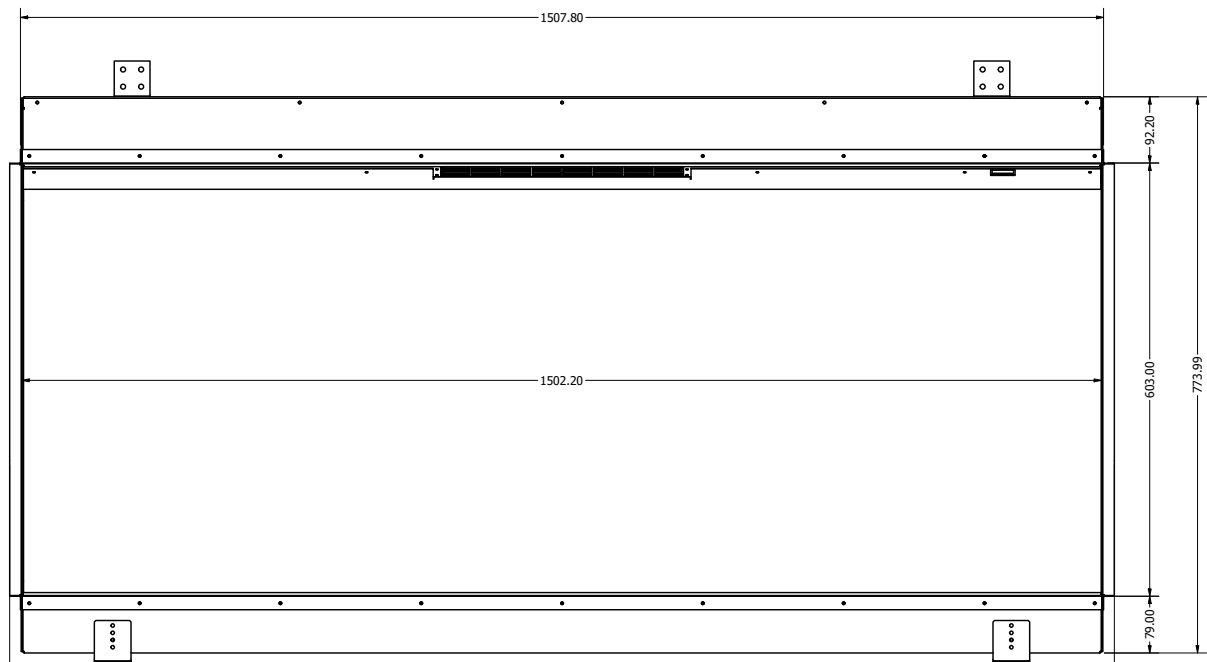
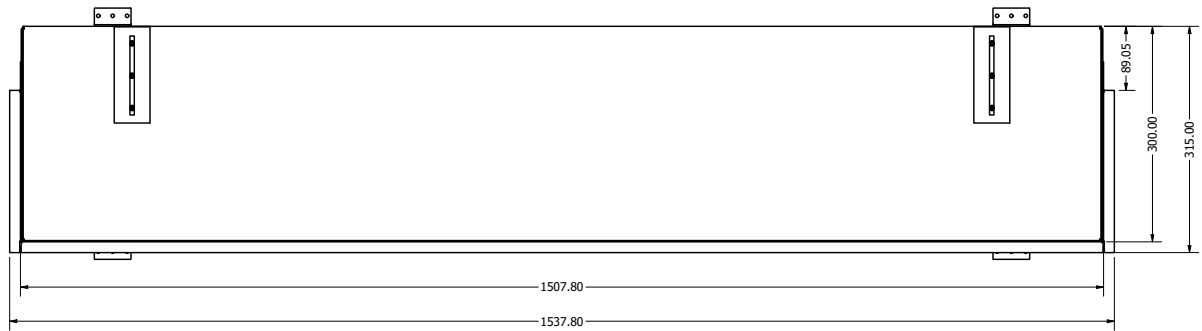

VOLEKTRA 1500

o **PRODUCT CATEGORY**
BUILT-INS

o **PRODUCT CODE**
VOLEKTRA1500HER



evonicfires.co.uk/built-ins-volektra/



PRODUCT SPECIFICATION

FLAME TYPE	ROTISSERIE
HEIGHT (A)	587mm
WIDTH (B)	1535mm
DEPTH (C)	300mm
GLASS TYPE	UHD ANTI-REFLECTIVE
LOG TYPE	HERITAGE
CONTROL METHOD	E-SMART PLUS APP OR BLACK REMOTE



PRODUCT SPECIFICATION		PRODUCT SPECIFICATION	
FLAME EFFECT	VOLEKTRA	LAUNCH DATE	TBC
FLAME COLOUR	1 FLAME COLOUR	BRAND	EVONIC
LOG SET	HERITAGE	PRODUCT CATEGORY	BUILT-IN
ENGINE FLAME	VOLEKTRA	MODEL	VOLEKTRA 1500
FUEL TYPE	ELECTRIC	COUNTRY OF ORIGIN	CHINA
CONTROLS	APP & REMOTE	UKCA	YES
E-SMART	YES	NICA	YES
APP TECHNOLOGY	YES	CE (EUROPE)	YES
HEAT OUTPUT	1500W	LOT 20	YES
HEAT SETTINGS	VARIABLE	WEEE	YES
VARIABLE THERMOSTAT	YES	PACKAGING	
LAMP STYLE	LED	BOX HEIGHT	780mm
POWER CORD	1.8M KETTLE	BOX WIDTH	1690mm
SAFETY CUT-OUT	YES	BOX DEPTH	450mm
CORE MATERIAL	STEEL	PALLET WIDTH	1700mm
ACCESSORIES		PALLET DEPTH	440mm
		UNITS PER PALLET	1 (Unique Pallet)
		WEIGHT	60kg

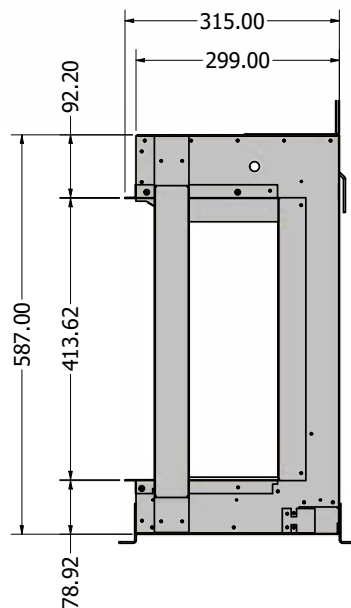
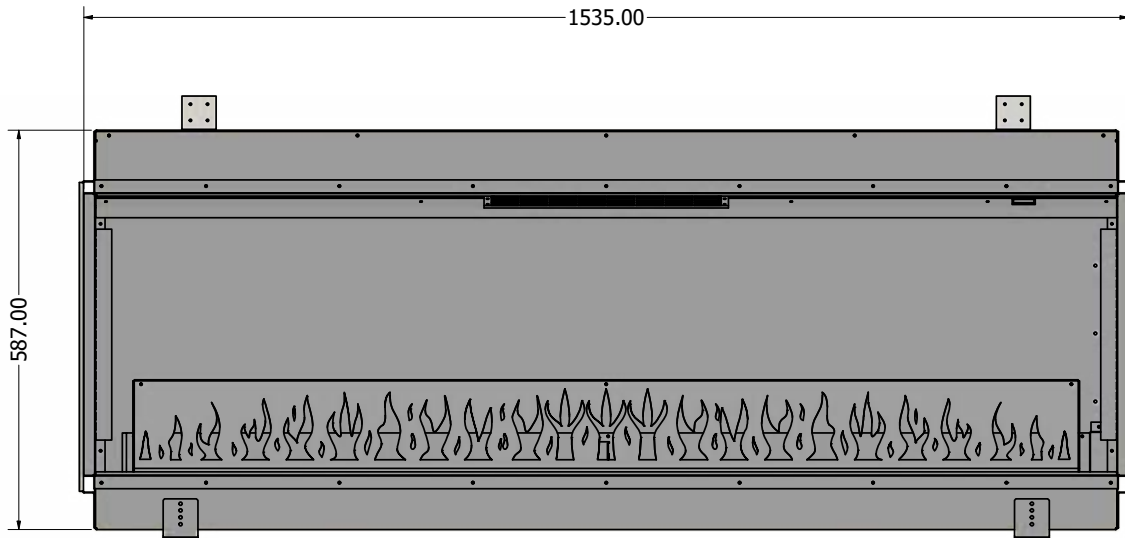
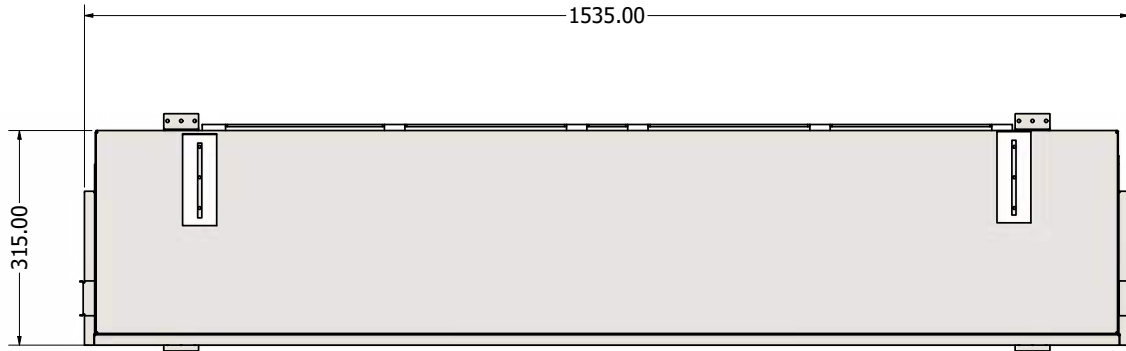

VOLEKTRA 1250

o **PRODUCT CATEGORY**
BUILT-INS

o **PRODUCT CODE**
VOLEKTRA1250HER



evonicfires.co.uk/built-ins-volektra/



PRODUCT SPECIFICATION

FLAME TYPE	ROTISSERIE
HEIGHT (A)	587mm
WIDTH (B)	1285mm
DEPTH (C)	300mm
GLASS TYPE	UHD ANTI-REFLECTIVE
LOG TYPE	HERITAGE
CONTROL METHOD	E-SMART PLUS APP OR BLACK REMOTE



PRODUCT SPECIFICATION		PRODUCT SPECIFICATION	
FLAME EFFECT	VOLEKTRA	LAUNCH DATE	TBC
FLAME COLOUR	1 FLAME COLOUR	BRAND	EVONIC
LOG SET	HERITAGE	PRODUCT CATEGORY	BUILT-IN
ENGINE FLAME	VOLEKTRA	MODEL	VOLEKTRA 1250
FUEL TYPE	ELECTRIC	COUNTRY OF ORIGIN	CHINA
CONTROLS	APP & REMOTE	UKCA	YES
E-SMART	YES	NICA	YES
APP TECHNOLOGY	YES	CE (EUROPE)	YES
HEAT OUTPUT	1500W	LOT 20	YES
HEAT SETTINGS	VARIABLE	WEEE	YES
VARIABLE THERMOSTAT	YES	PACKAGING	
LAMP STYLE	LED	BOX HEIGHT	780mm
POWER CORD	1.8M KETTLE	BOX WIDTH	1410mm
SAFETY CUT-OUT	YES	BOX DEPTH	370mm
CORE MATERIAL	STEEL	PALLET WIDTH	1445mm
ACCESSORIES		PALLET DEPTH	400mm
		UNITS PER PALLET	1 (Unique Pallet)
		WEIGHT	50kg

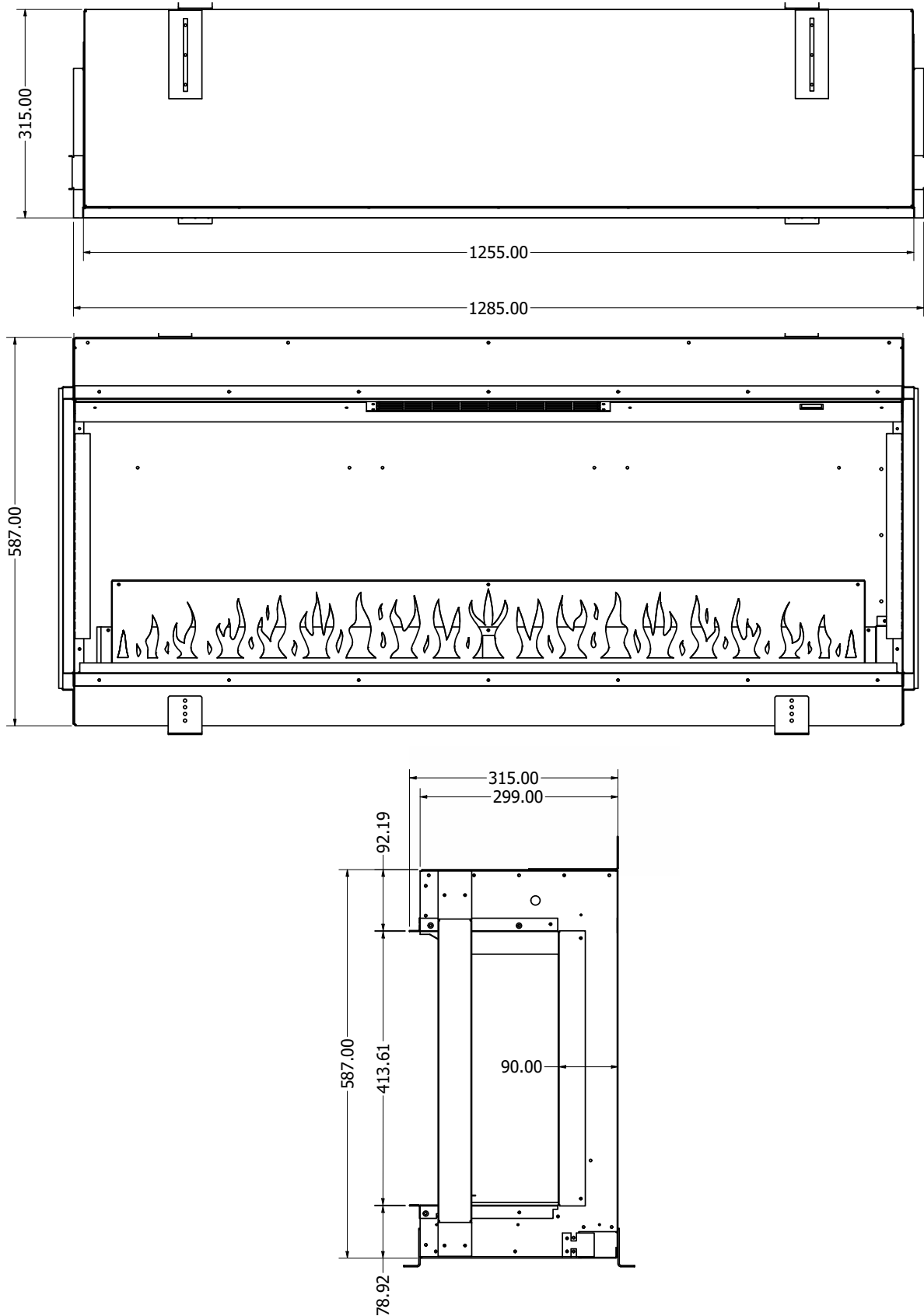

VOLEKTRA 1000

o **PRODUCT CATEGORY**
BUILT-INS

o **PRODUCT CODE**
VOLEKTRA1000HER



evonicfires.co.uk/built-ins-volektra/



PRODUCT SPECIFICATION

FLAME TYPE	ROTISSERIE
HEIGHT (A)	587mm
WIDTH (B)	1034mm
DEPTH (C)	300mm
GLASS TYPE	UHD ANTI-REFLECTIVE
LOG TYPE	HERITAGE
CONTROL METHOD	E-SMART PLUS APP OR BLACK REMOTE



PRODUCT SPECIFICATION		PRODUCT SPECIFICATION	
FLAME EFFECT	VOLEKTRA	LAUNCH DATE	TBC
FLAME COLOUR	1 FLAME COLOUR	BRAND	EVONIC
LOG SET	HERITAGE	PRODUCT CATEGORY	BUILT-IN
ENGINE FLAME	VOLEKTRA	MODEL	VOLEKTRA 1000
FUEL TYPE	ELECTRIC	COUNTRY OF ORIGIN	CHINA
CONTROLS	APP & REMOTE	UKCA	YES
E-SMART	YES	NICA	YES
APP TECHNOLOGY	YES	CE (EUROPE)	YES
HEAT OUTPUT	1500W	LOT 20	YES
HEAT SETTINGS	VARIABLE	WEEE	YES
VARIABLE THERMOSTAT	YES	PACKAGING	
LAMP STYLE	LED	BOX HEIGHT	780mm
POWER CORD	1.8M KETTLE	BOX WIDTH	1410mm
SAFETY CUT-OUT	YES	BOX DEPTH	370mm
CORE MATERIAL	STEEL	PALLET WIDTH	1445mm
ACCESSORIES		PALLET DEPTH	400mm
		UNITS PER PALLET	1 (Unique Pallet)
		WEIGHT	40kg

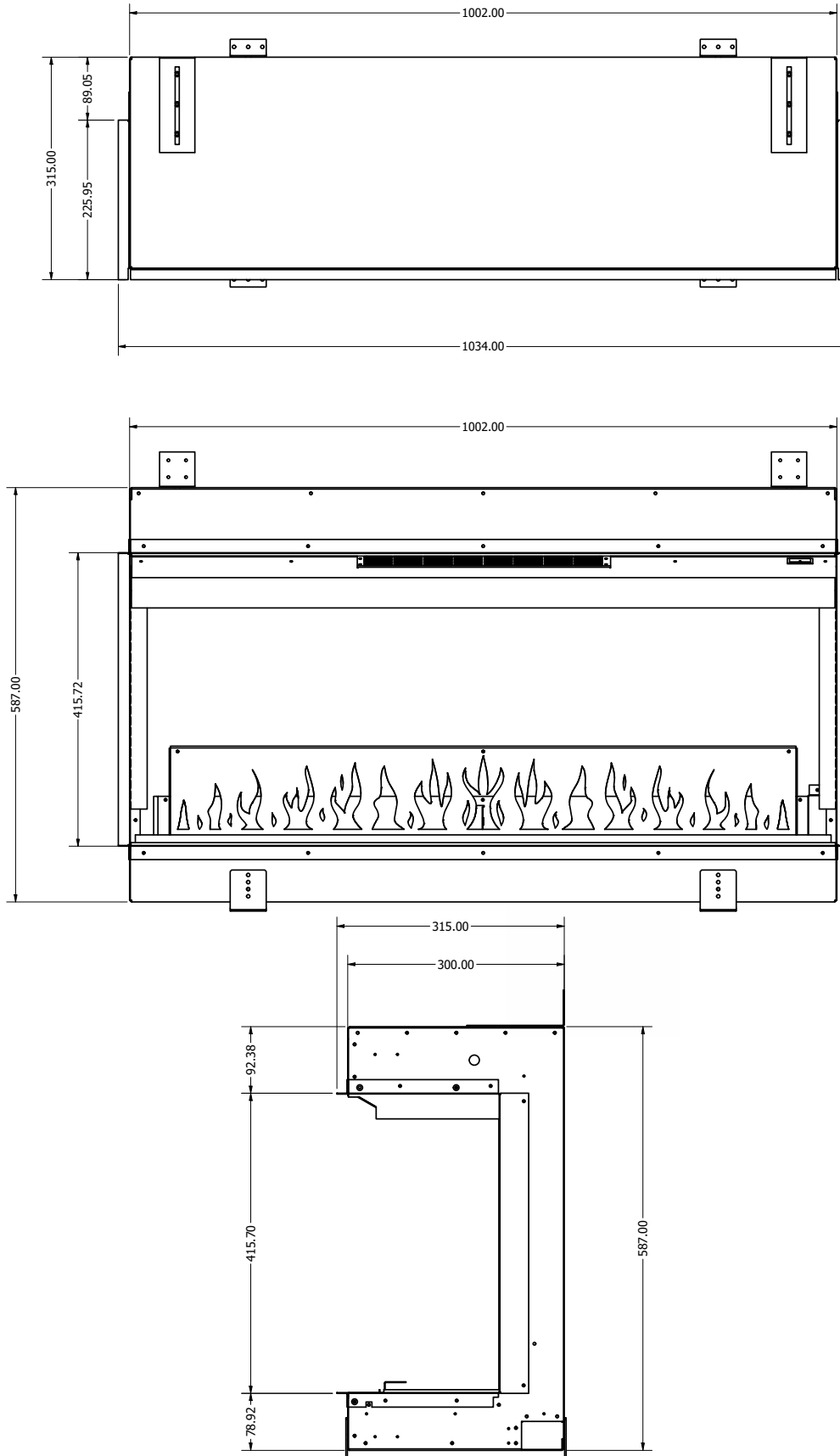

VOLEKTRA 800

o **PRODUCT CATEGORY**
BUILT-INS

o **PRODUCT CODE**
VOLEKTRA800HER



evonicfires.co.uk/built-ins-volektra/



PRODUCT SPECIFICATION

FLAME TYPE	ROTISSERIE
HEIGHT (A)	762mm
WIDTH (B)	836mm
DEPTH (C)	300mm
GLASS TYPE	UHD ANTI-REFLECTIVE
LOG TYPE	HERITAGE
CONTROL METHOD	E-SMART PLUS APP OR BLACK REMOTE



PRODUCT SPECIFICATION		PRODUCT SPECIFICATION	
FLAME EFFECT	VOLEKTRA	LAUNCH DATE	TBC
FLAME COLOUR	1 FLAME COLOUR	BRAND	EVONIC
LOG SET	HERITAGE	PRODUCT CATEGORY	BUILT-IN
ENGINE FLAME	VOLEKTRA	MODEL	VOLEKTRA 800
FUEL TYPE	ELECTRIC	COUNTRY OF ORIGIN	CHINA
CONTROLS	APP & REMOTE	UKCA	YES
E-SMART	YES	NICA	YES
APP TECHNOLOGY	YES	CE (EUROPE)	YES
HEAT OUTPUT	1500W	LOT 20	YES
HEAT SETTINGS	VARIABLE	WEEE	YES
VARIABLE THERMOSTAT	YES	PACKAGING	
LAMP STYLE	LED	BOX HEIGHT	1000mm
POWER CORD	1.8M KETTLE	BOX WIDTH	1150mm
SAFETY CUT-OUT	YES	BOX DEPTH	430mm
CORE MATERIAL	STEEL	PALLET WIDTH	995mm
ACCESSORIES		PALLET DEPTH	400mm
		UNITS PER PALLET	1 (Unique Pallet)
		WEIGHT	40kg

