

evonicfires

quality electric fires built in britain

INSTRUCTIONS MUST BE KEPT AFTER INSTALLATION IN CASE
OF FUTURE MAINTENANCE

Inset Instruction Guide

Models – COLORADO – IOWA – DETROIT
– MEMPHIS – KANSAS – KEPLER 22 –
NEBRASKA



Important Safety Information

Always read this manual first before attempting to install or use this fireplace. For your safety, always comply with all warnings and safety instructions contained in this manual to prevent personal injury or property damage.

Please Note: This product is for well insulated spaces or occasional use.

English Insets-300120

SERIAL NUMBER LABEL

Contents

1. Introduction	2
2. Electrical Safety	3/4
3. Important Instructions	5/6
4. Installation Requirements	7
5. Operating Instructions	8
6. Setting Thermostat	9
7. Attaching & Removing Detroit Fascia	10
8. Colorado Front Glass Removal	11
9. Memphis Infill Plate Installation	12
10. Memphis-Kansas Tie back Installation	13
11. Memphis-Kansas Cast Frame	14
12. Technical Specification	15
13. Problem Solving Chart	16/19
14. Warranty	20

welcome to evonicfires

Evonic fires is an award-winning brand of CK Fires Ltd, situated just outside Stratford-upon-Avon, we manufacture a range of British built electric fires and are considered as one of the most technically advanced manufacturers in the world, with optional controllers such as e-touch and a fully integrated APP available to download on both



This guide is designed to aid in the installation and continued performance of this product. This product conforms with all health, safety, and environmental protection standards as indicated by a CE mark. For optimum performance this product requires a well insulated location or occasional use.

ELECTRICAL SAFETY:

When using electrical appliances, basic precautions should always be followed to reduce the risk of fire, electric shock, and injury to persons, including the following:

- ① Read all instructions before using this electric fireplace.
- ② This fireplace is hot when in use. To avoid burns, do not let bare skin touch hot surfaces. The trim around the heater outlet becomes hot during heater operation. DANGER: High temperatures may be generated under certain abnormal conditions. Do not partially or fully cover or obstruct the front of this heater.
- ③ Extreme caution is necessary when any heater is used by or near children or people of reduced mobility and whenever the unit is left operating and unattended.
- ④ Young children should be supervised to ensure that they do not play with the appliance.
- ⑤ The appliance is not intended for use by young children or infirmed persons without supervision.
- ⑥ In the event of a malfunction, disconnect power at the service panel and have the unit inspected by a reputable electrician before reusing.
- ⑦ If the supply cord is damaged, it must be replaced by the manufacturer, or its service agent, or a qualified person in order to avoid a hazard.
- ⑧ Do not use outdoors.
- ⑨ Never locate fireplace where it may fall into a bathtub or other water container.
- ⑩ To disconnect the fireplace, turn the controls off, and turn off power to heater circuit at main disconnect panel.
- ⑪ Do not run the cord under carpeting. Do not cover cord with throw rugs, runners, or the like. Arrange cord away from traffic area and where it will not be tripped over.
- ⑫ Do not locate the heater immediately below a fixed socket-outlet.

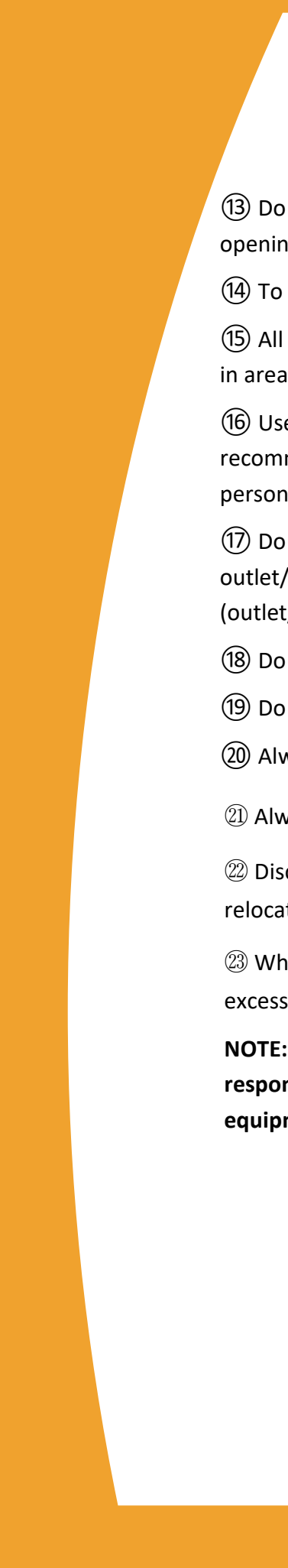
- 
- ⑬ Do not insert or allow foreign objects to enter any ventilation or exhaust opening as this may cause an electric shock or fire, or damage to the heater.
 - ⑭ To prevent a possible fire, do not block air intakes or exhaust in any manner.
 - ⑮ All electrical heaters have hot and arcing or sparking parts inside. Do not use in areas where gasoline, paint, or flammable liquids are used or stored.
 - ⑯ Use this fireplace only as described in this manual. Any other use not recommended by the manufacturer may cause fire, electric shock or injury to persons.
 - ⑰ Do not change the plug in any way. Always plug heaters directly into a wall outlet/receptacle. Never use with an extension cord or relocatable power tap (outlet/power strip).
 - ⑱ Do not burn wood or other materials in the electric fireplace.
 - ⑲ Do not strike the fireplace glass.
 - ⑳ Always use a certified electrician should new circuits or outlets be required.
 - ㉑ Always use properly grounded, fused and polarized outlets.
 - ㉒ Disconnect all power supply before performing any cleaning, maintenance or relocation of the unit.
 - ㉓ When transporting or storing the unit and cord, keep in a dry place, free from excessive vibration and store so as to avoid damage.

NOTE: Changes or modifications not expressly approved by the party responsible for compliance could void user's authority to operate the equipment.

IMPORTANT INSTRUCTIONS:

Important electrical safety:

This appliance must never be installed above or in front of a fixed electric socket.

The electrical socket must be easily accessible to isolate the supply during maintenance and cleaning.

This appliance is supplied with a two meter power lead, which has a 13Amp moulded three pin plug to connect to a standard 230/240V plug socket.

This appliance must always be earthed. If in any doubt consult a suitably competent person.

Replacement plug: (Please note that it may invalidate your warranty if the moulded plug is removed)

This appliance must only be connected to a 230/240 Volts AC 50Hz supply. Before connecting the fire, check that the supply voltage is the same as stated on the fire. This appliance must only be used on a AC supply, fuse rating 13Amp.

The wires in the mains lead are coloured in accordance with a standard UK supply, these being:

GREEN/YELLOW –EARTH

BLUE –NEUTRAL

BROWN –LIVE

As the colours of the mains lead of this appliance may not match the coloured markings used to identify the terminals in a plug, please observe the following:

- The green and yellow wire must be connected to the terminal in the plug which is marked with the letter E or the earth symbol.
- The blue wire must be connected to the terminal in the plug marked with the letter N.
- The brown wire must be connected to the terminal in the plug marked with the letter L.
- If the plug is damaged, replace or consult a qualified electrician.
- Replace fuses only with fuses of the correct size and rating.

Servicing:

Only a competent person should service this appliance.

This appliance **must** be serviced every 12 months.

Warning: Before carrying out any repairs or servicing, ensure that the power supply cord is removed from the mains supply.

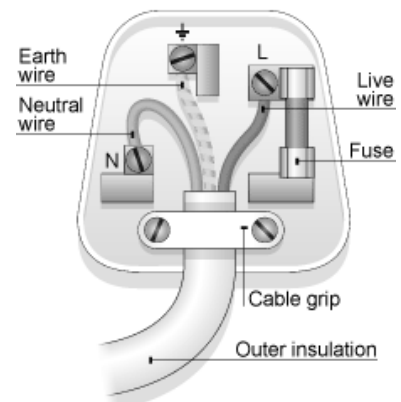

All Evonic fires products meet the requirements of the EC Directives 2004/108/EC and 2006/95/EC.

These directives have been met by compliance with the following standards:

EU 2011-65/EU 2015/863

BS EN 60335-1:2002

BS EN 60335-2-30:2003

BS EN 6100-6-3:2001

Please read these instructions before installation or use and keep this booklet handy for future reference.

Safety:

This appliance is not intended for use by persons (including children) with reduced physical, sensory or mental capabilities, or lack of experience and knowledge, unless they have been given supervision or instruction concerning the use of the appliance by a person responsible for their safety.

Children should be supervised to ensure that they do not play with the appliance.

General Warnings:

Never leave children unsupervised with an unguarded heater.

Never obstruct or cover the heater outlet.

Never install or use this product where it may come in contact with water i.e. a bathroom or wet room.

Never use aerosols or steam cleaners near this product.

Never route the electric cable near the heater outlet.

Never route the electric cable under carpets or floor coverings.

Never install this product close to curtains or combustible materials.

Never use the heater to dry clothes or other objects.

Never remove the fireplace surrounding without isolating the electric supply.

Important electrical safety:

This appliance must never be installed above or in front of a fixed electric socket.

The electrical socket must be easily accessible to isolate the supply during maintenance and cleaning.

This appliance is supplied with a two meter power lead, which has a 13Amp moulded three pin plug to connect to a standard 230/240V plug socket.

This appliance must always be earthed. If in any doubt consult a suitably competent person.

All Evonic fires products meet the requirements of the EC Directives 2004/108/EC and 2006/95/EC.

INSTALLATION REQUIREMENTS:

INSTALLATION REQUIREMENTS:

INSET MODELS:

This product has been designed to be installed into a standard 420mm(W) x 570mm(H) x 80mm(D)

If the product is to be installed into an open chimney or flue, it is important that the chimney/flue is blocked off to prevent any up/down draughts and falling debris which could restrict and alter the airflow to the product.

It is also important to ensure that the product has a minimum clearance around it of 15mm, this is to ensure that the product can circulate the required airflow for the heater unit.

The product should never be sealed into an opening with the use of silicones or adhesives as this can also alter the airflow and hinder any further servicing of the product.

Please refer to the technical specification table for further information, with reference to measurements.

(Heater unit cut-out) (This is a safety feature, to safeguard against further damage to the product).

If the airflow is restricted the heater will automatically turn off. This can occur due to incorrect installation or obstruction.

To reset the heater function:

- isolate from the mains power supply.
- Leave product to cool.
- After a suitable cooling down period, remove the obstruction if obstructed, and check installation.
- After 10 minutes the thermo switch (cut-out) in the heater will reset.

Please note that both the effect fan and heater fan omit a low decibel noise, both of which are normal operating characteristics.

Operating Instructions

The appliance can be operated manually using the rocker switch to the right of the heater outlet, or by remote control. To operate, first press the right master switch (located on the right side of the product) which is marked (O/I) to the (I) position then perform the following actions:

FLAME EFFECT ONLY (NO HEAT)

Manual – Press the rocker switch on the appliance once.

Remote – Press the button marked  on the remote handset.

FLAME EFFECT WITH 750W OF HEAT

Manual – Press the second rocker switch on the appliance to the (I) position.

Remote – Press the button marked  on the remote handset.

FLAME EFFECT WITH 1500W OF HEAT

Manual – Press the third rocker switch on the appliance to the (II) position.

Remote – Press the button marked  on the remote handset.

STANDBY MODE – NO HEAT OR FLAME EFFECT

Manual – Press the first rocker switch on the appliance to the (O) position.

Remote – Press the button marked  on the remote handset.

FLAME EFFECT – DIMMER FUNCTION

Manual – N/A No dimmer function on a manual control product.

Remote – Press the button marked  on the remote handset once, and then again to stop the dimmer at the desired setting.

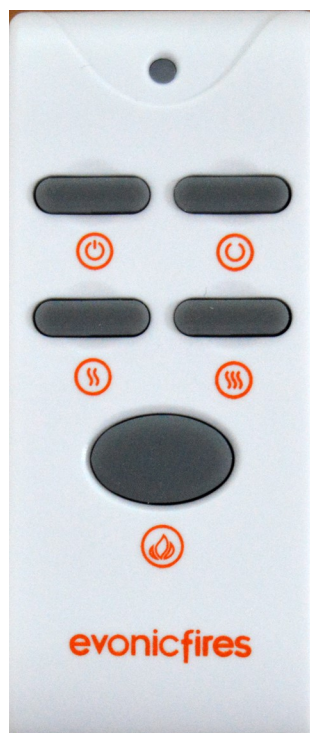

Setting the Thermostat

Note: This only applies to **MANUAL** fires

Ensure the fire is plugged in.

Start by pressing the 'light' button on the left. This will activate your LED's and bottom blower.

For heat setting, ensure the thermostat knob is turned fully to the right (max temperature).

Once this has been completed, you can choose to have either 750W or 1500W of heat given from your fire.

For 750W, simply press the middle button with the single line at the bottom (heat 1).

For 1500W, repeat this process but also turn the right switch on marked with 2 lines at the bottom (heat 2).

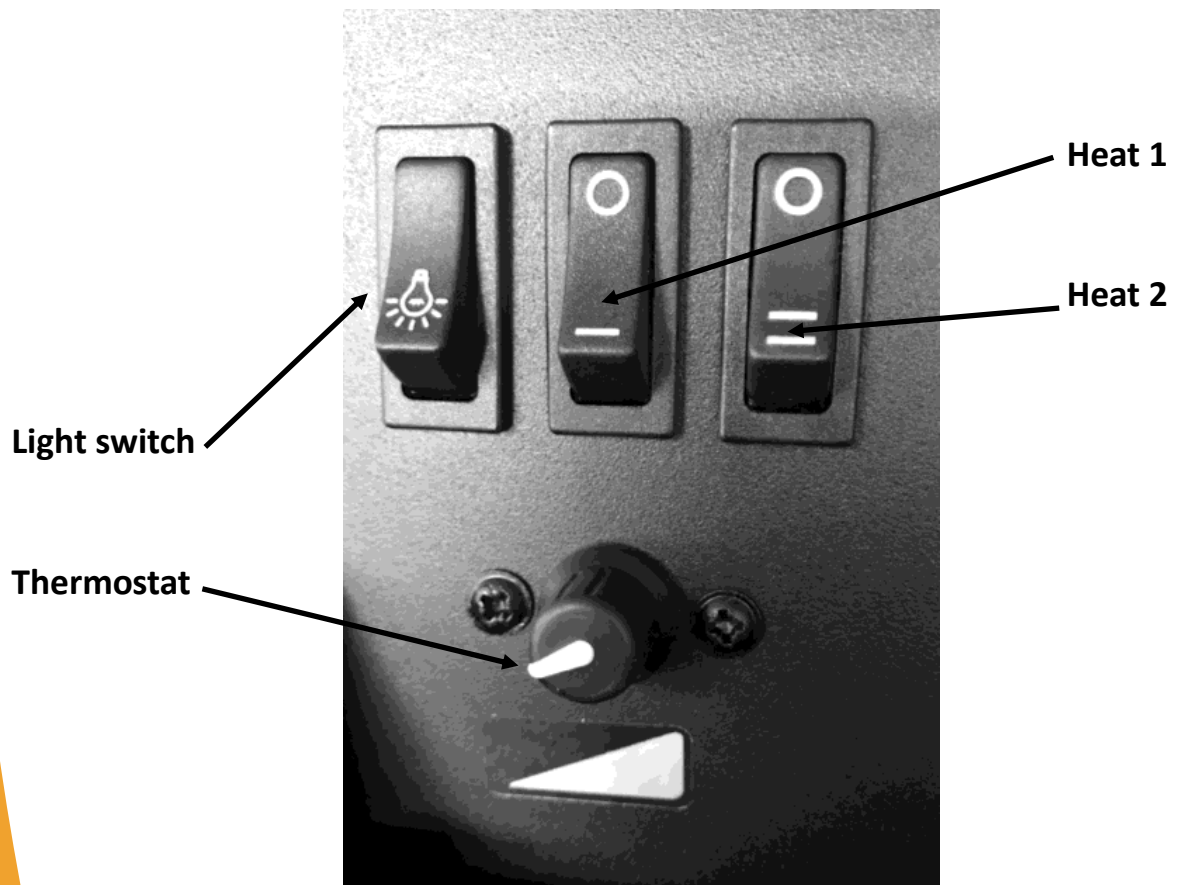

Attaching & Removing Detroit Fascia

Suggested fuel layout:



Fig:1) – Place the ceramic fuel set into the product as shown above.

Fig:2) - Align the keyhole slots of the Detroit fascia with the bolts in the main body of the product.

Fig:3) – Once aligned, push the Detroit fascia over the bolts, and then push down to lock the door in position.

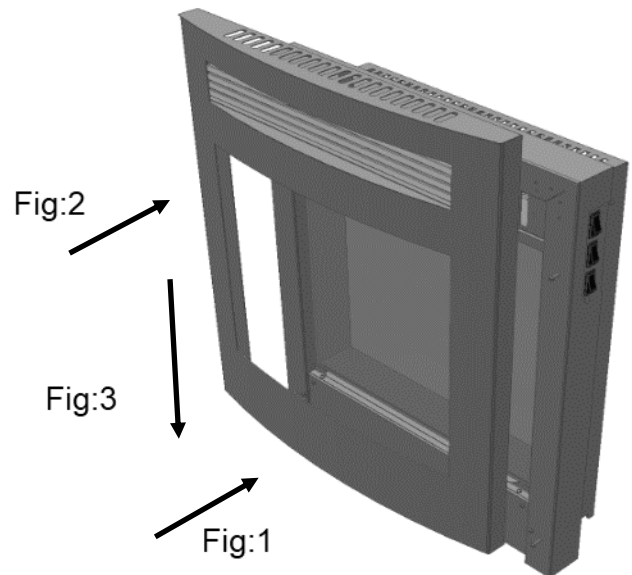
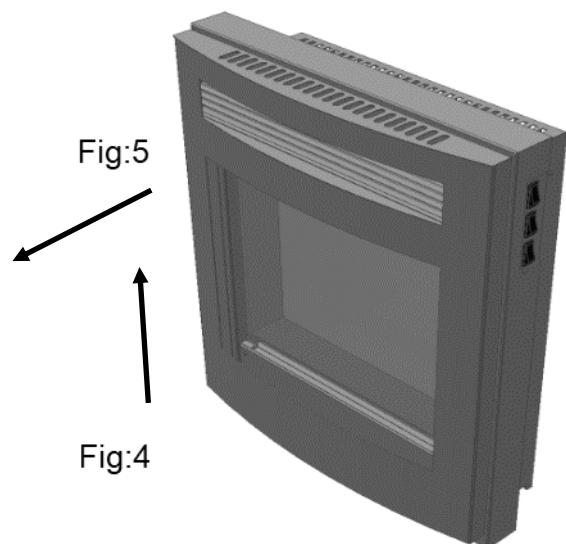

Fig:4) – To remove the fascia, pull in a upward motion.

Fig:5) – Then pull the fascia away from the main body.



This is applicable to models; Detroit

Colorado-Kepler 22 Front Glass Removal

To install the fuel set (Logs, Pebbles, Coals) the below steps must be taken.

1. Remove outer frame, this is held in place with magnets.

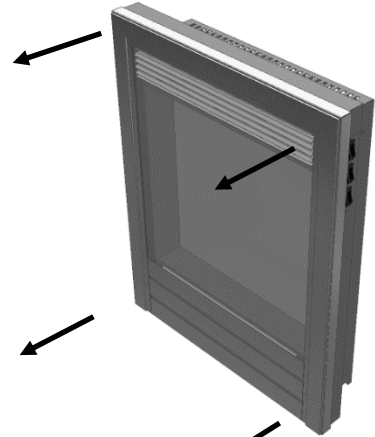

2. Remove the two screws located in the bottom glass retaining bar.

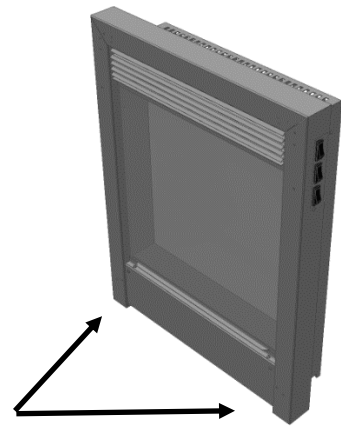

3. Remove the glass by pulling the retaining bar away from the body of the fire, ensure that this glass is supported at all times.

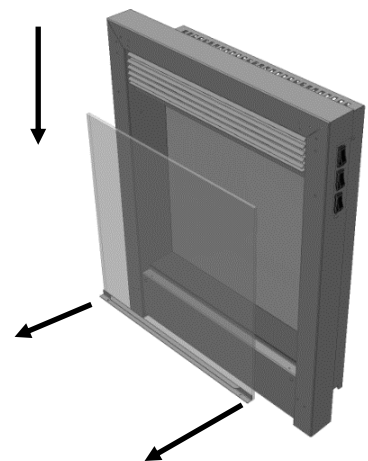

4. Place the fuel set (Logs, Pebbles, Coals) on the fuel bed as to your own specification.

5. To replace the glass, please reverse the above steps.

This is applicable to models; Colorado/Kepler 22

Memphis Infill Plate Installation

To install the Memphis infill plate please follow the below steps:

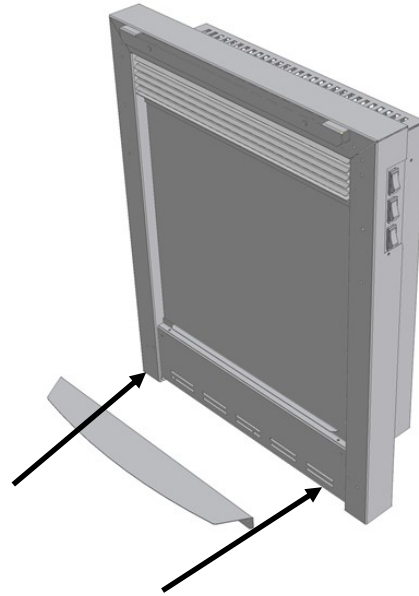

1. Remove the x2 screws located in the front plate as indicated.
2. Feed the x2 screws through the x2 holes in the Memphis infill plate.

3. Screw and fix the Memphis infill plate to the front plate located on the fire.

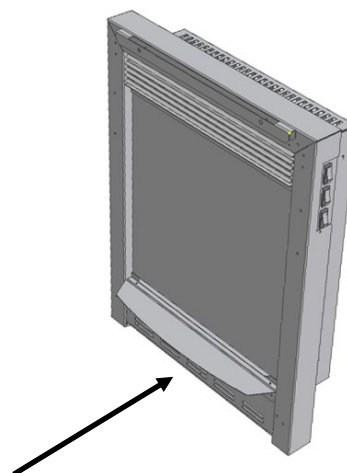

This is applicable to models; Memphis

Memphis-Kansas Tie Back Installation

1. Screw and fix the eyelet into the top of the installation aperture.
Fig:1
2. Feed the wire first through the body of the fire and then through the eyelet. Fig:2
3. Once threaded through the eyelet, feed back through the same hole on the fire body to create a loop.
4. Move the fire back into the opening, whilst pulling the excess slack of the cable tight.
5. Cut the cable 50mm away from the body of the fire.
6. Feed the straddle clamp onto the end of the wire, and screw tight.
Fig:3

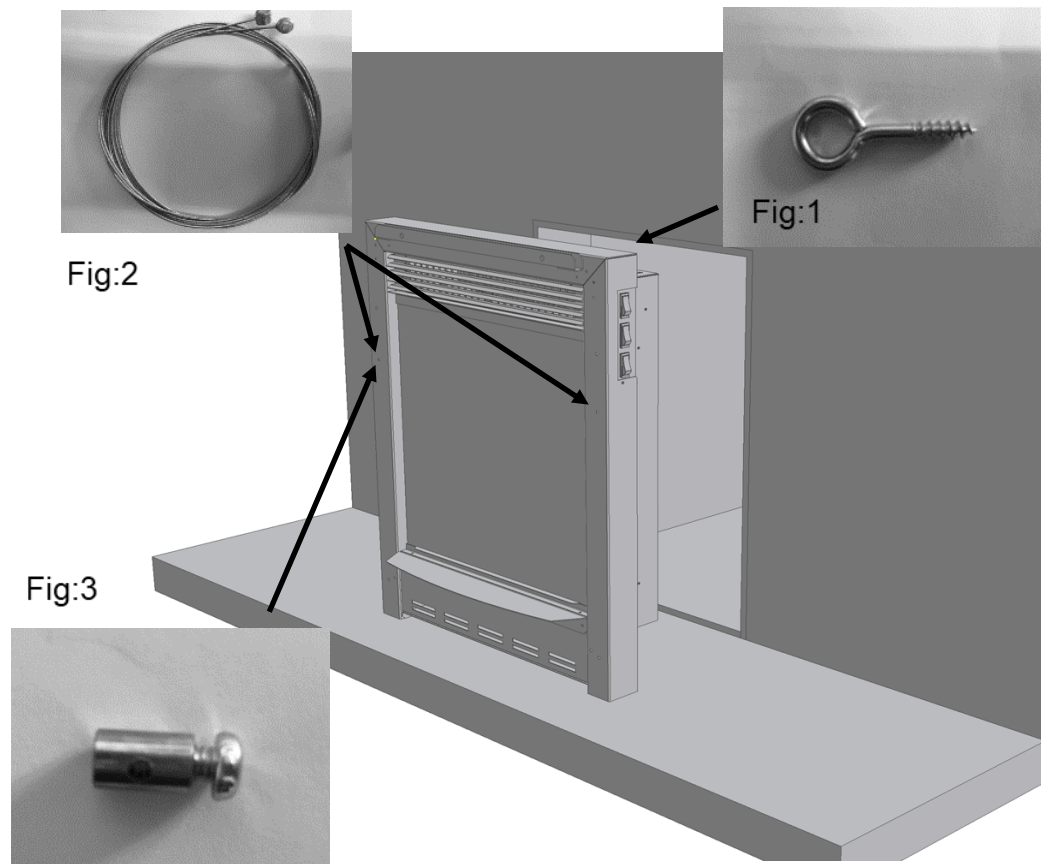

This is applicable to models; Memphis/Kansas

Memphis-Kansas Cast Frame

1. Once the product is installed into position.
2. Fix the cast fascia by hooking the tags on the rear of the cast into the cast fixing bracket.

Fig 1

3. Once in position secure the cast frame by screwing the 2x M4 bolts provided through the fascia into the body of the fire.
4. Place ash-pan into position.

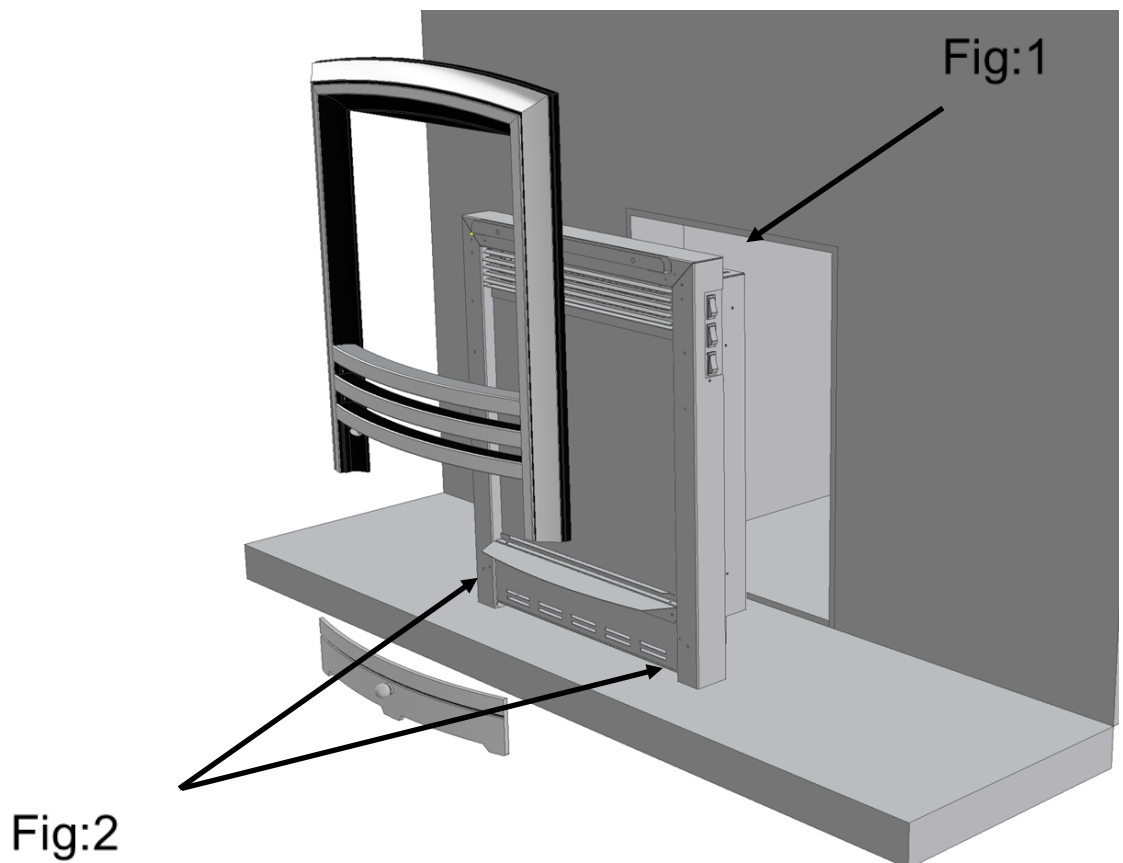

This is applicable to models; Memphis/Kansas

Technical Specification

<u>MODEL</u>	<u>TOTAL HEIGHT</u>	<u>TOTAL WIDTH</u>	<u>TOTAL DEPTH</u>	<u>INSET HEIGHT</u>	<u>INSET WIDTH</u>	<u>INSET DEPTH</u>
COLORADO	605MM	460MM	130MM	550MM	382MM	75MM
IOWA	605MM	490MM	130MM	550MM	382MM	60MM
DETROIT	590MM	460MM	180MM	550MM	382MM	75MM
MEMPHIS	615MM	515MM	200MM	550MM	382MM	75MM
KANSAS	615MM	515MM	200MM	550MM	382MM	75MM
KEPLER 22	605MM	645MM	135MM	550MM	382MM	75MM

Troubleshooting Flow Chart:

Problem

Possible Cause

Solution

1) Flames not working correctly	→ Ribbons are statically connected to glass.	→ Spray some anti-static spray beneath the tray.
	→ Installation airflow restricted.	→ Check the correct aperture has been adhered to when installing— Recommended clearance is 100mm .
	→ Blower clogged.	→ Fan requires cleaning out.
	→ Slow fan.	→ Fan requires cleaning out. If problem persists, replacement fan may be required.

2) Heater blowing cold	→ Possible installation gaps/Chimney not adequately blocked off.	→ Chimney may not be fully blocked. Correct aperture has not been adhered to— 100mm
	→ Fan clogged.	→ Heater fan requires cleaning out
	→ Faulty element.	→ Replace element
	→ Slow fan.	→ Check fan placement. If problem persists replacement fan may be required.

Problem

Possible Cause

Solution

3)

Noisy Heater

Fan unbalanced.

Adjust fan to stop catching on the case. If problem persists replacement fan unit maybe required.

Fan catching on housing.

Adjust fan to stop catching on the case

Fan clogged.

Fan requires cleaning out. If problem persists a replacement fan may be required.

Fan has come loose.

Tighten fan cradle or screws holding fan onto fan cradle.

4)

Noisy Flame Effect

Fan unbalanced.

Adjust fan to stop catching on the case. If problem persists a replacement fan unit may be required.

Fan catching on housing.

Adjust fan to stop catching on the case.

Fan clogged.

Fan requires cleaning out. If problem persists a replacement fan may be required.

Fan has come loose.

Tighten fan cradle or screws holding fan onto fan cradle.

Problem

Possible Cause

Solution

5) Fire not turning on.	→	Rocker switch has not been turned to the 'ON' position.	→	Double check switches are turned to the 'ON' position.
	→	Remote/App not paired.	→	Remote needs pairing. See separate pairing instructions for guide.
	→	Fuse blown.	→	Replace fuse.
	→	Unit not plugged in correctly.	→	Check to be sure the power lead is plugged in adequately.

6) No lights	→	Loose connection or disconnected wire.	→	Check all connections on LED's
	→	LED shorting out	→	Check location of short—Replace LED strip if necessary.
	→	LED blown	→	LED strip needs replacing.
	→	Blown driver on PCB	→	PCB needs replacing.

Problem	Possible Cause	Solution
<p>7) Heater coming on randomly</p>	<p>Timer has been accidentally set.</p>	<p>Double check timer settings.</p>
	<p>Thermostat faulty.</p>	<p>Replace PCB.</p>
<p>8) LED streaking</p>	<p>LED dropped down.</p>	<p>LED needs to be re-stuck into place.</p>
	<p>Log positioning.</p>	<p>Change log positioning to hide any direct view of LED strip.</p>
<p>9) Heater cutting out</p>	<p>Build up of hot air triggering heater cut-out unit.</p>	<p>Ensure the appliance has the required aperture for air to circulate and prevent build-up. Recommended 100mm</p>

Conditions of warranty:

If this appliance should prove to be defective due to faulty design, materials or workmanship within 12 months of purchase, the product will be repaired free of charge, subject to the following conditions:

The electric fire shall have been purchased and used solely within the UK and Ireland for domestic purposes and in accordance with the Users operating instructions.

It is the purchasers responsibility to prove that the unit is under warranty, e.g. receipt of purchase.

All warranties, will be invalidated if unauthorised repairs or modifications are made to the electric fire, or in case of accident, misuse or damage caused by improper installation, or to damage occurring during transit to or from the repairer and altered or missing serial numbers.

Any parts, which have been replaced under this warranty, shall become our property.

The company shall not be liable for any consequential loss or damage what so ever, arising from or in connection with this electric fire.

This Warranty does not apply to Heating elements, Bulbs or fuses.

'No fault found', service calls and installation errors are not covered under the manufacturers warranty and will result in a charge being made for the Call-Out by our appointed service engineer.

This warranty is in addition to and does not affect the purchasers statutory rights of consumers.

Registering product:

To register a product please visit: **www.evonicfires.co.uk** and complete the fields required under the **Register a Product Section**. By registering your appliance, an extra 12 months of cover will be added to your warranty.

CK Fires Ltd / Evonic Fires

1 Evonic house, Clifford park, Clifford lane, Stratford-Upon-Avon, CV37 8HW

Tel: +44 (0) 1789 263868 Fax: +44 (0) 1789 293080

