

# evonicfires



Built-Ins specification booklet

# Contents

|                     |    |
|---------------------|----|
| E-Ilusion 800       | 3  |
| Karlstad/e2400      | 4  |
| Avesta/e1800        | 5  |
| Linnea/e1500        | 6  |
| Kiruna/e1030/Valter | 7  |
| Lindstrom/e1030DS   | 8  |
| Tyrell/e800         | 9  |
| Motala/e1250        | 10 |
| Newton 10/e1000     | 11 |
| Newton 9/e900       | 12 |
| Newton 7/e700       | 13 |
| Newton 6/e600       | 14 |
| Kallan/e730         | 15 |
| Thoren/e630         | 16 |
| e1560               | 17 |
| e810                | 18 |
| e810DS              | 19 |
| e500                | 20 |
| e710                | 21 |
| e640                | 22 |



# E-Ilusion 800

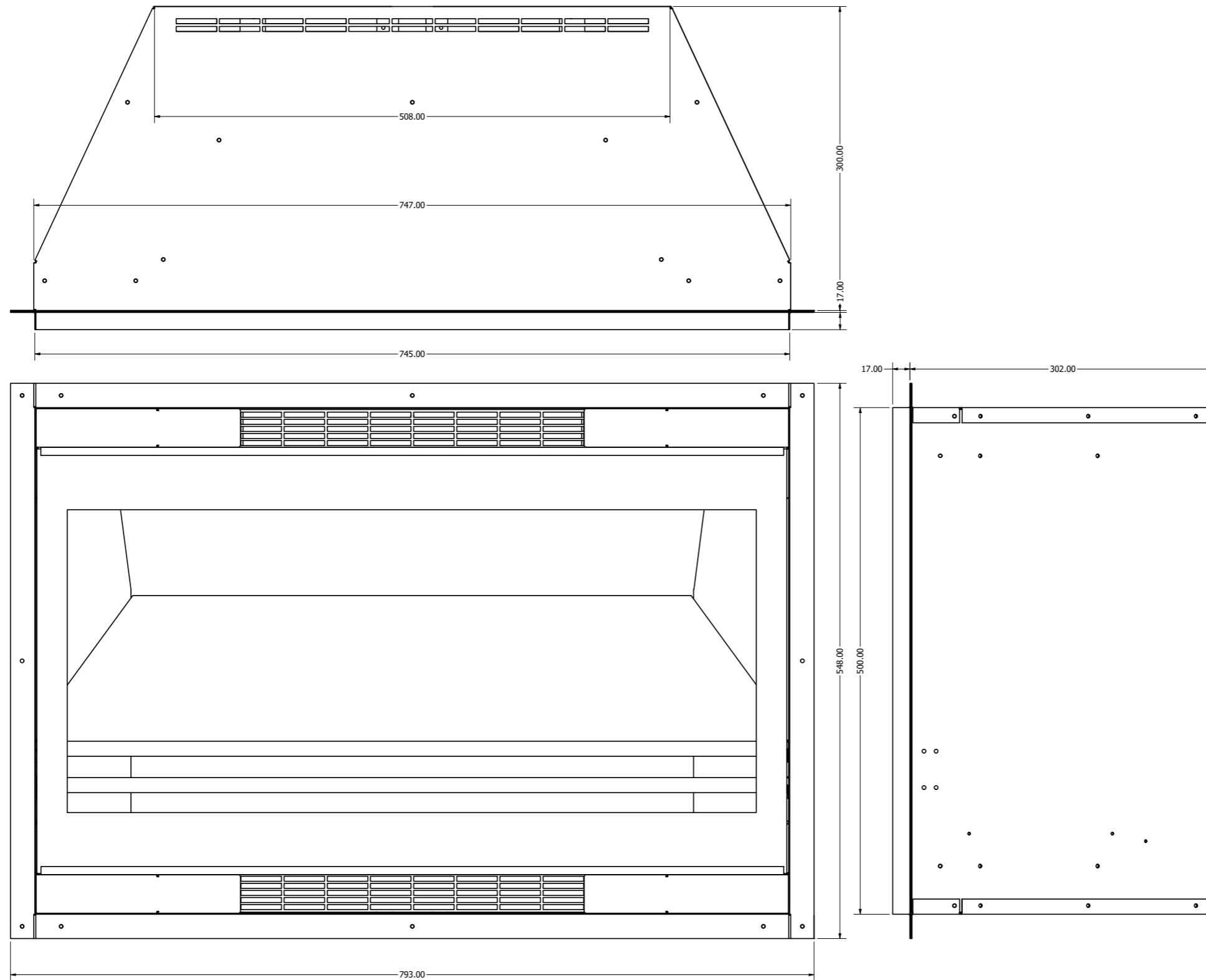

# Karlstad/E2400

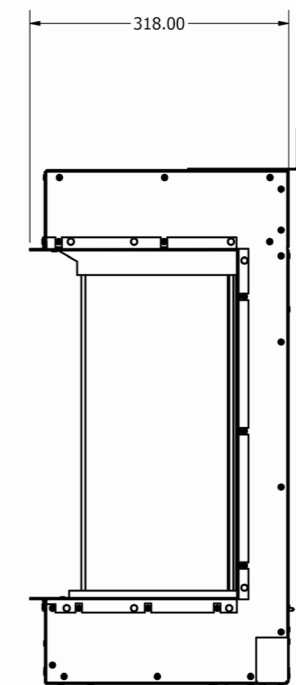
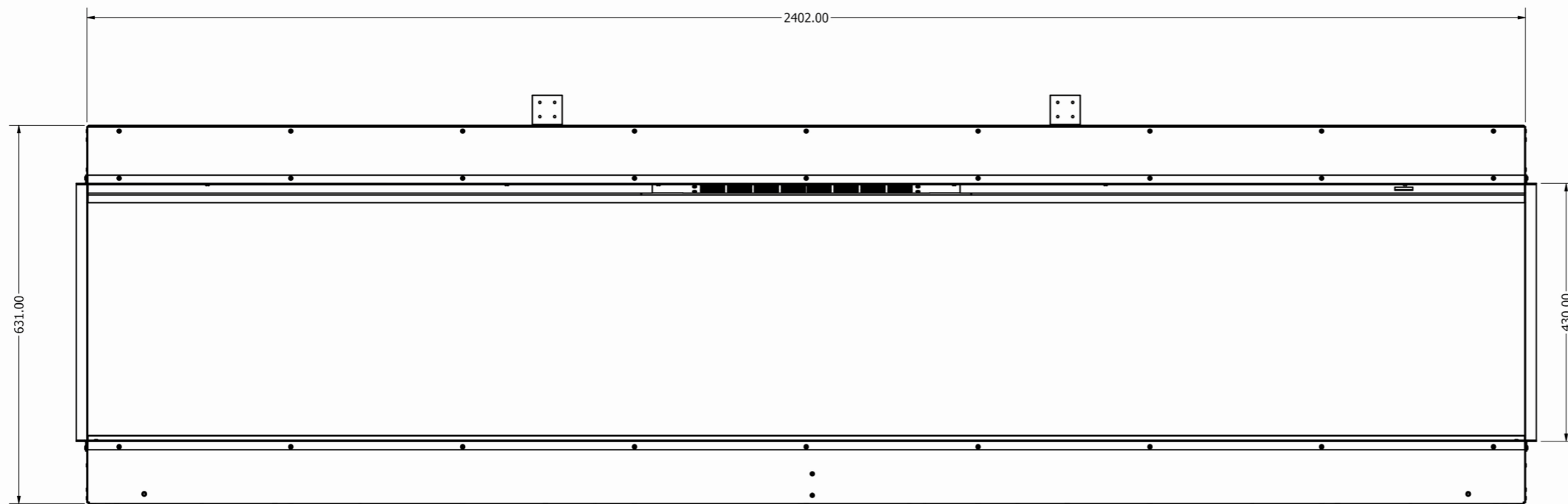
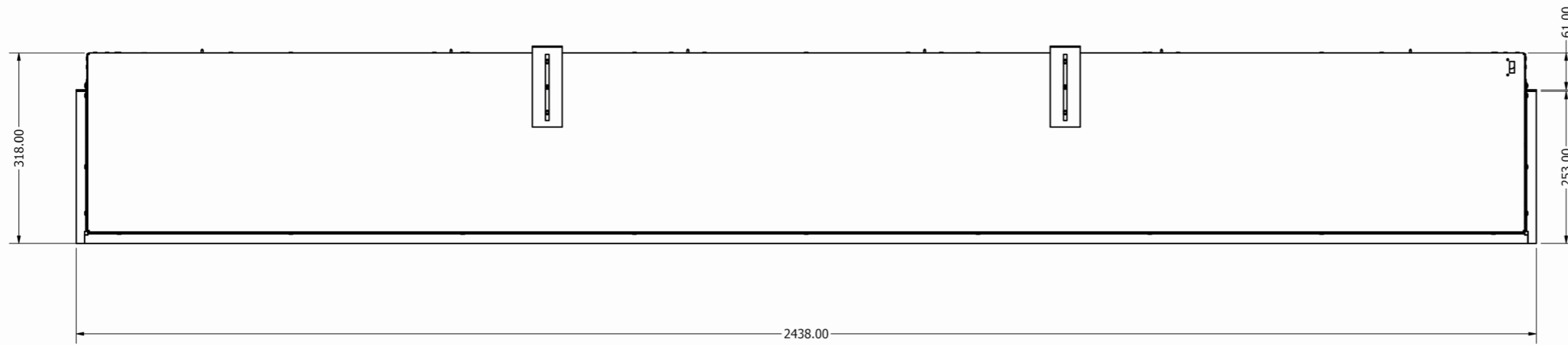

# Avesta/E1800

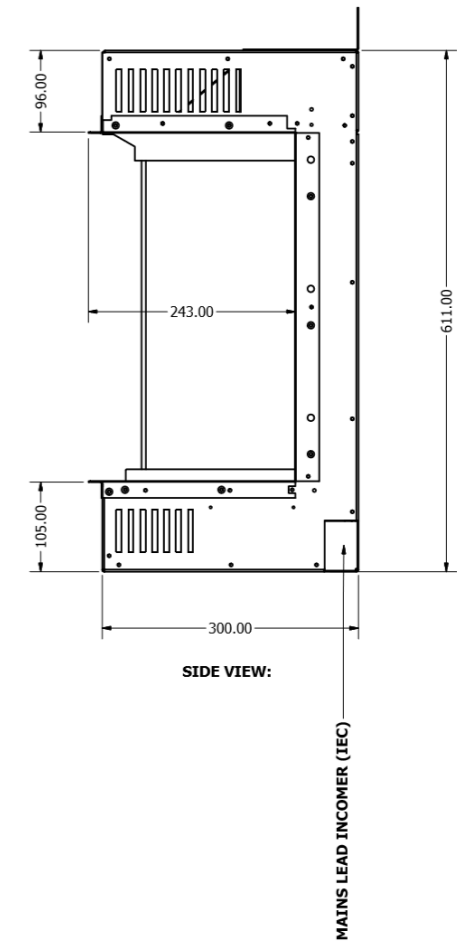
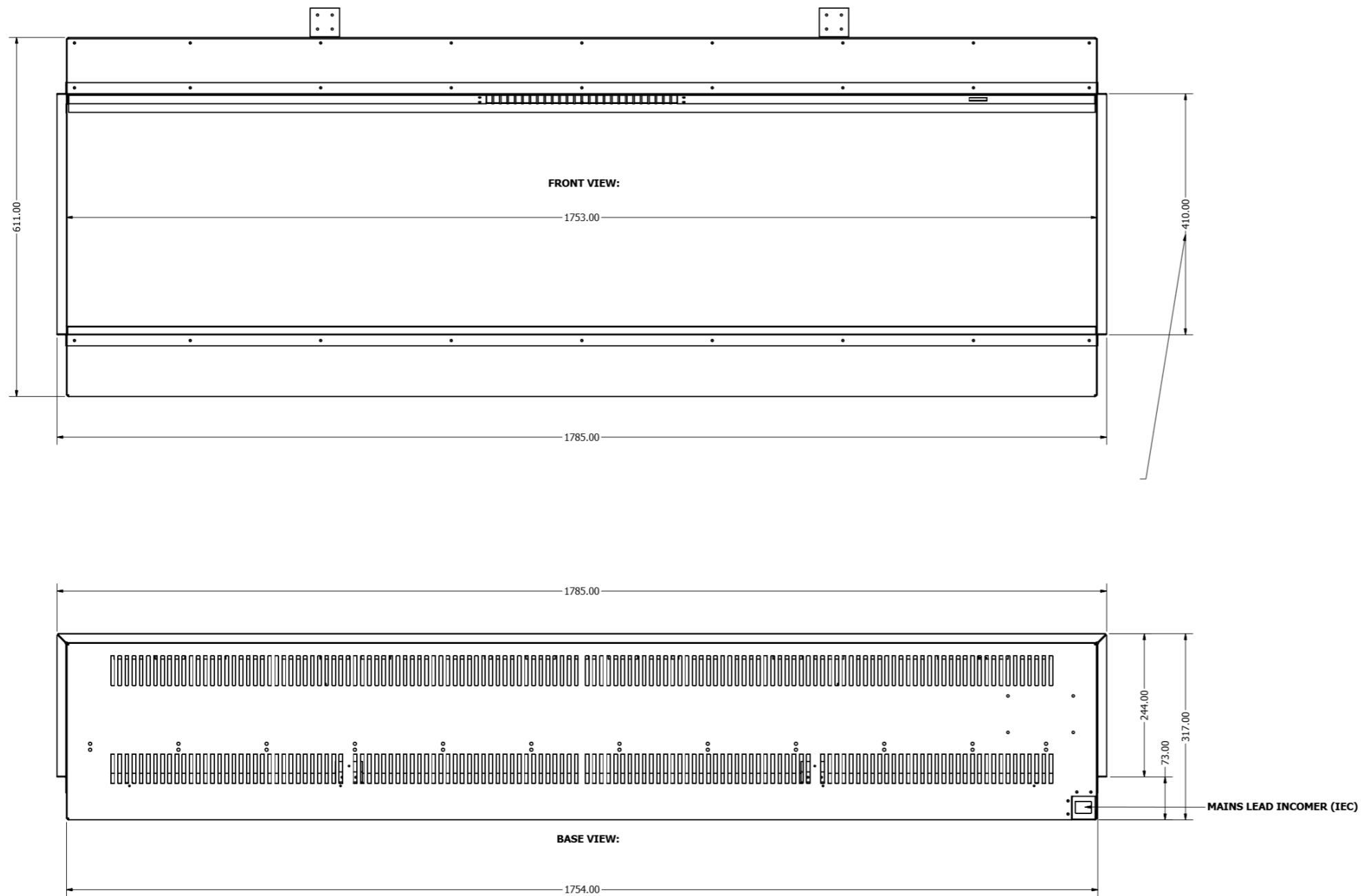

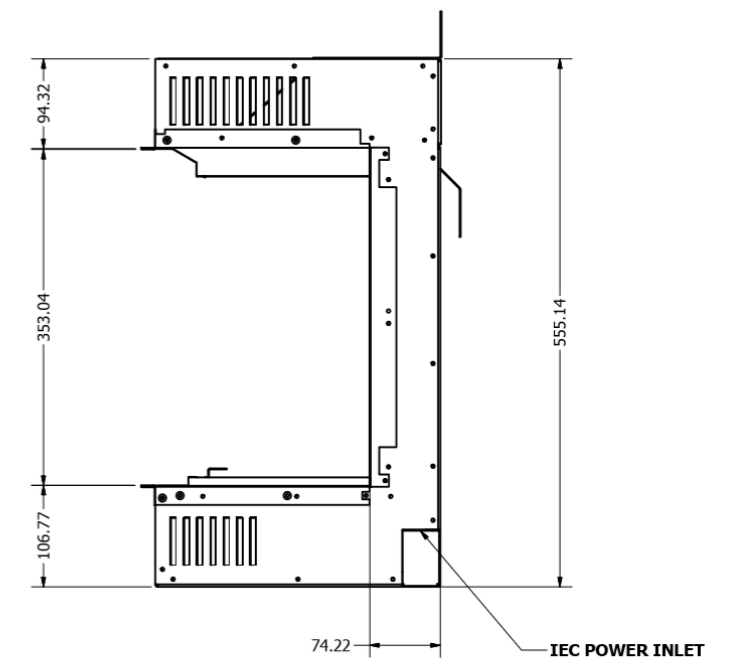
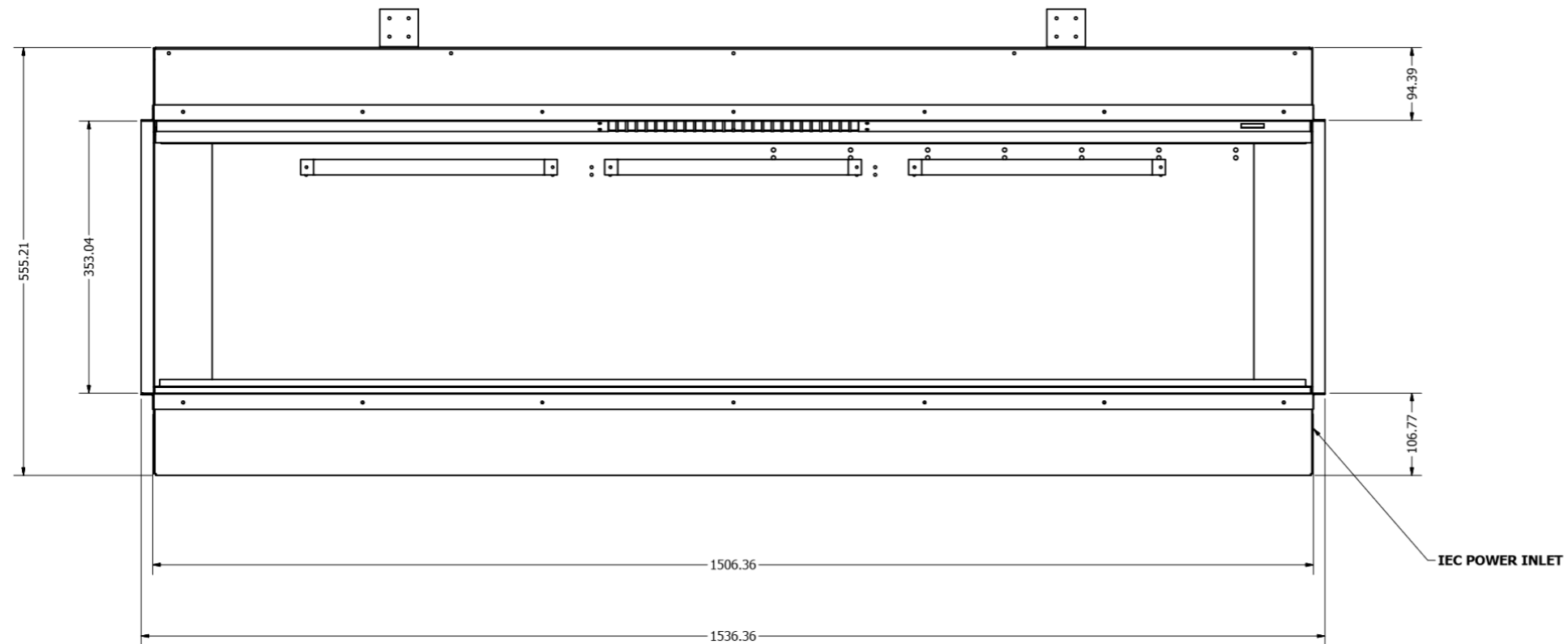
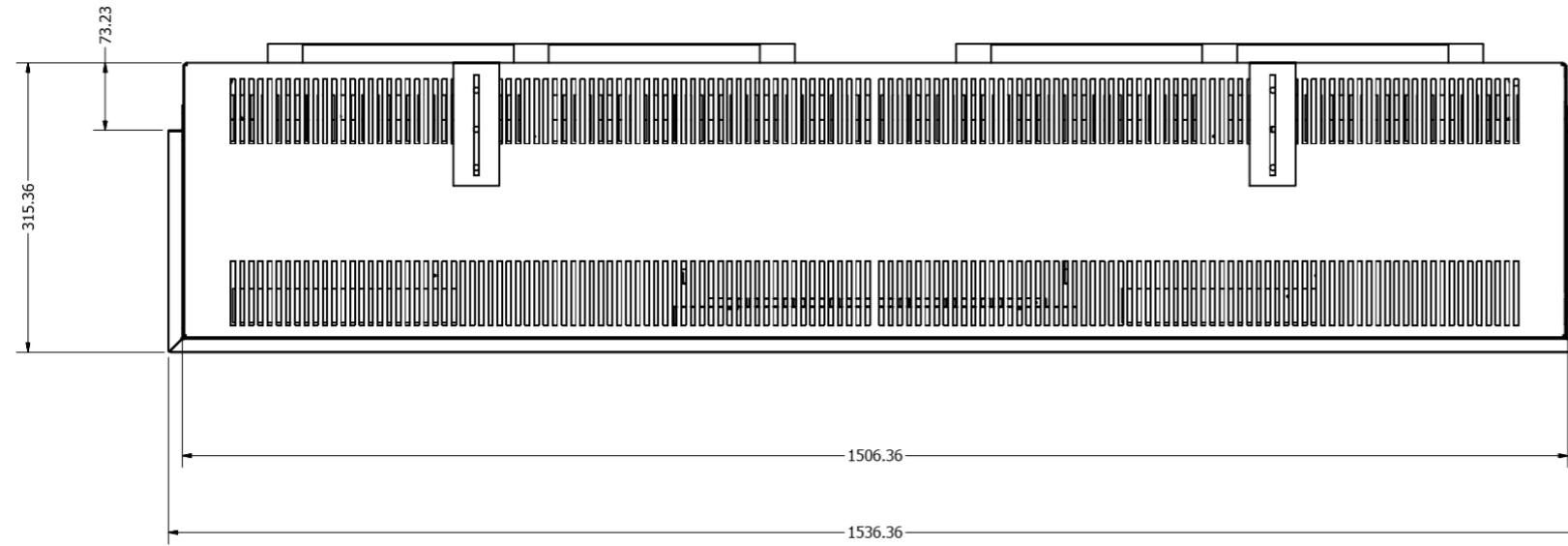

# Kiruna/E1030/Valter

KIRUNA WITH TILE WING

WIDTH - 1418mm  
HEIGHT - 570mm

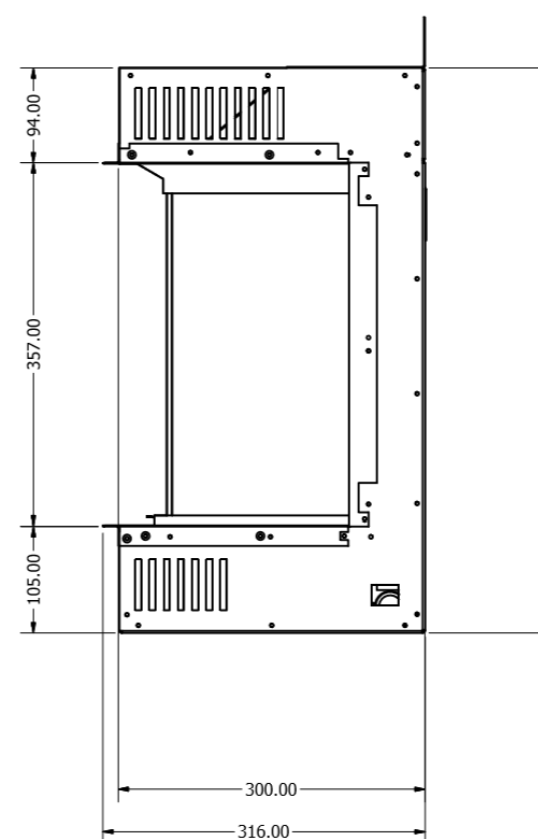
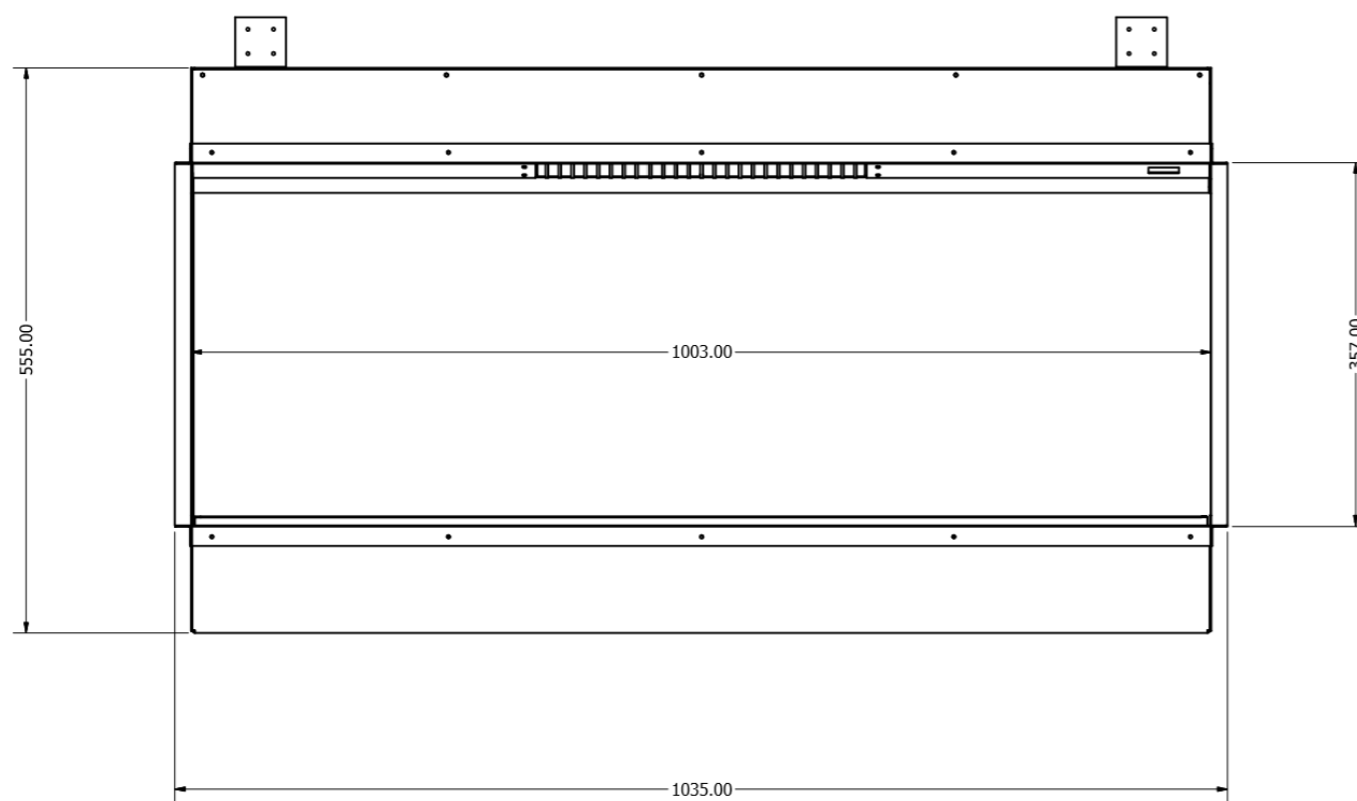
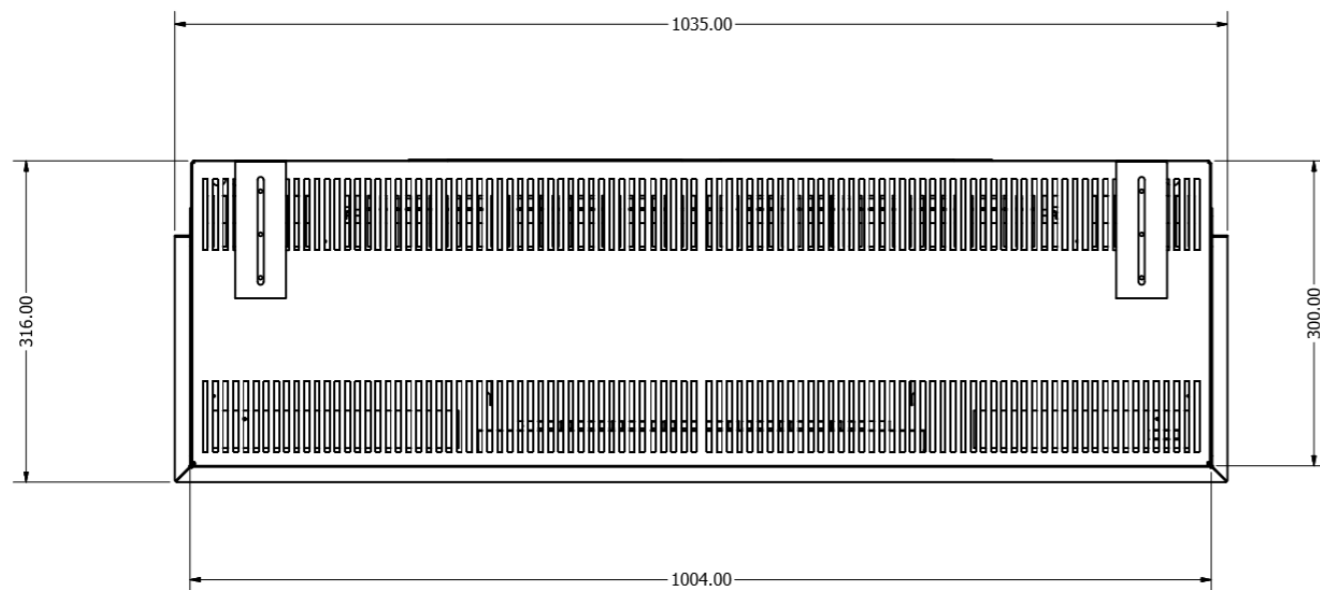

# Lindstrom/E1030DS

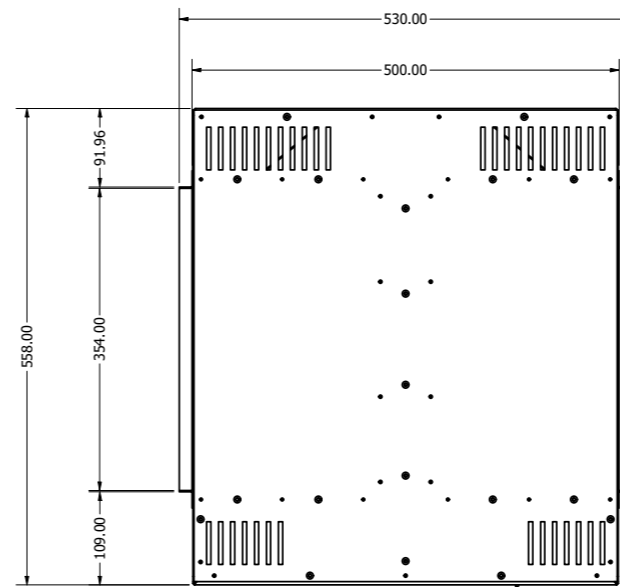
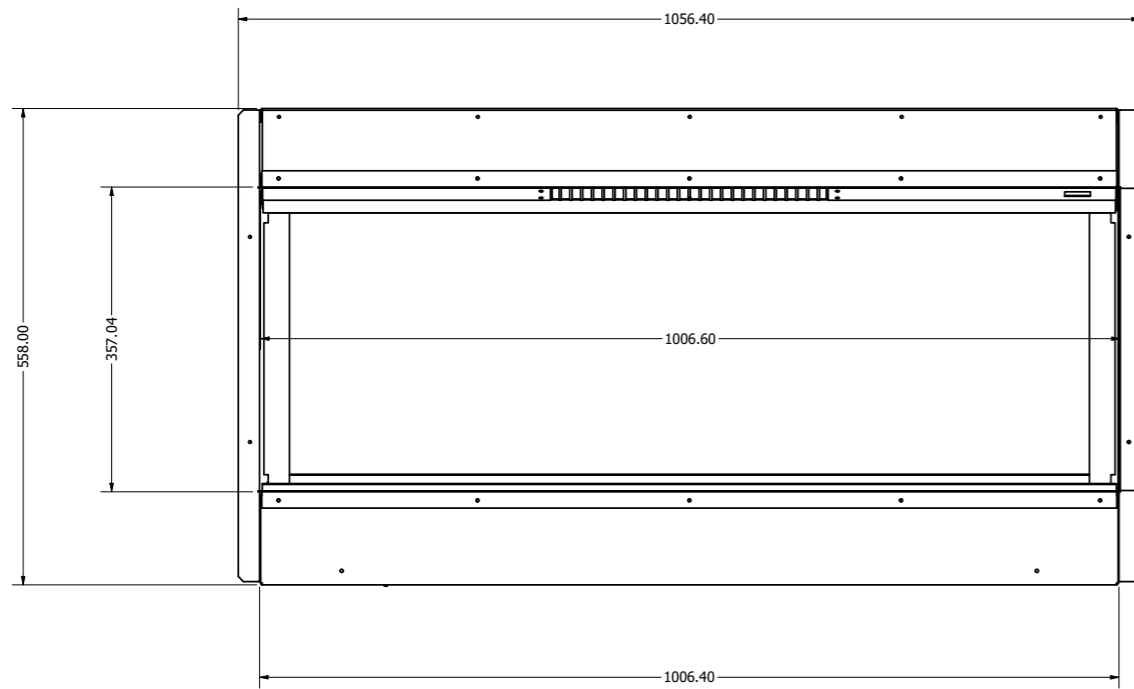
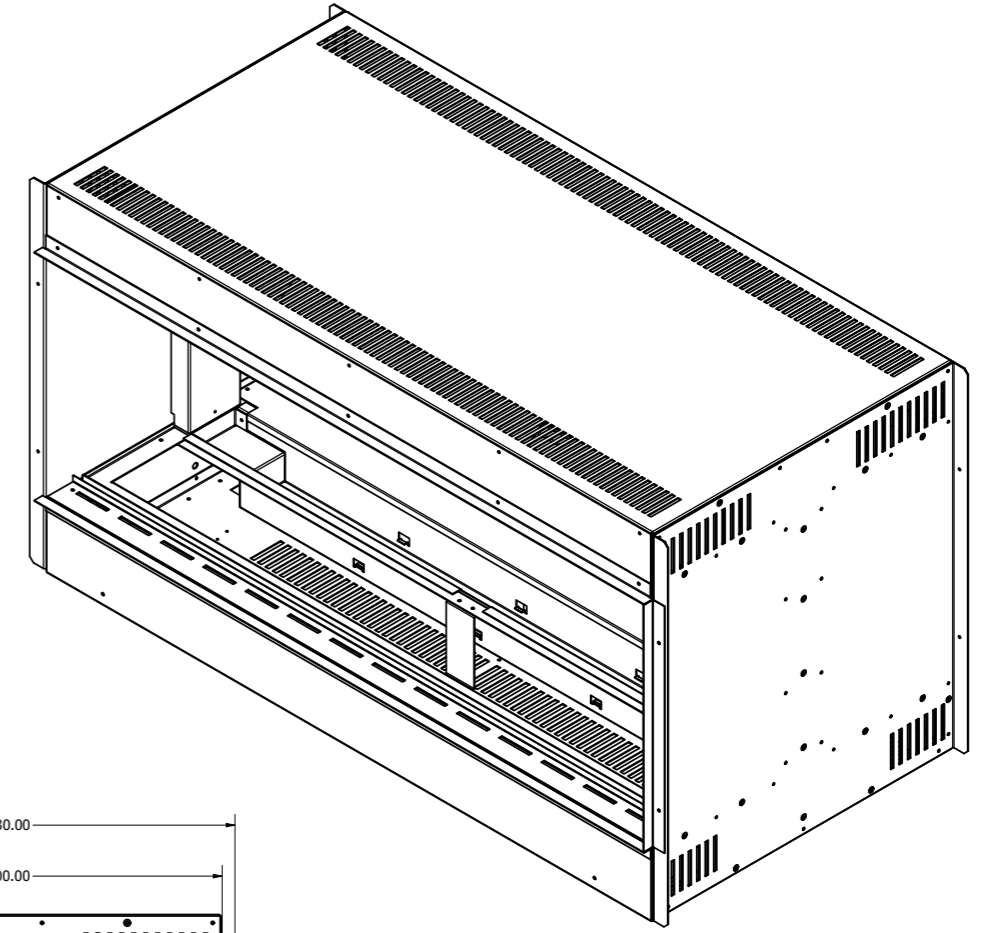
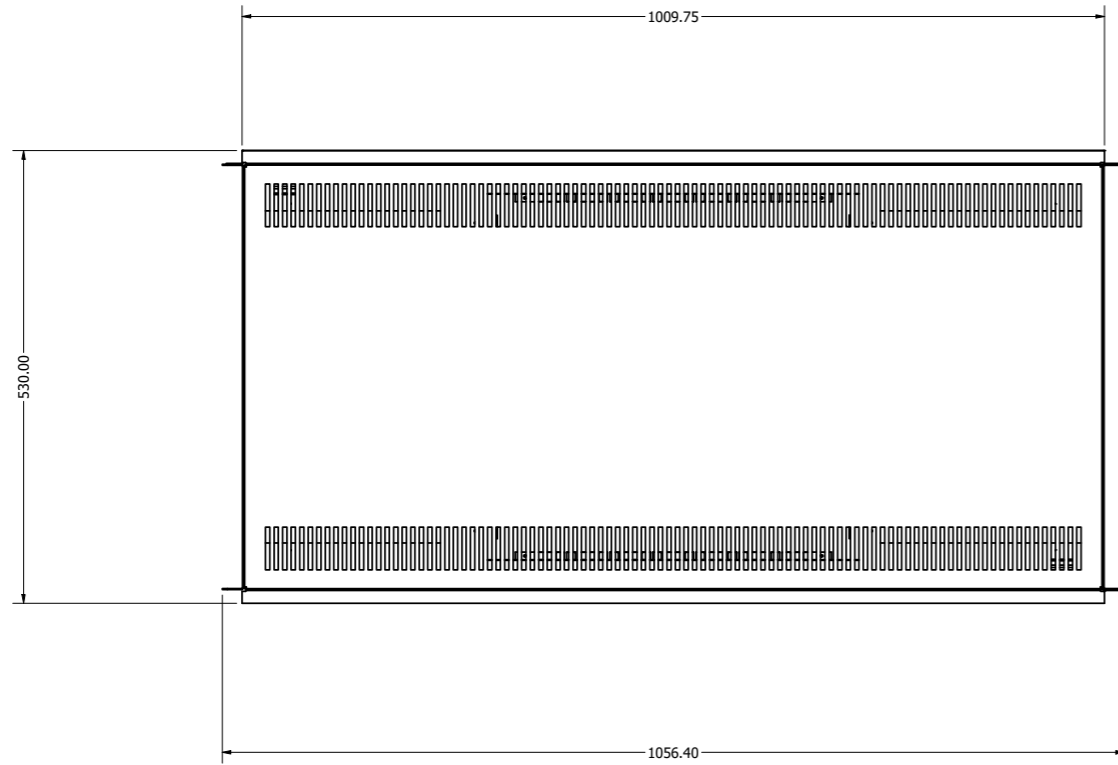



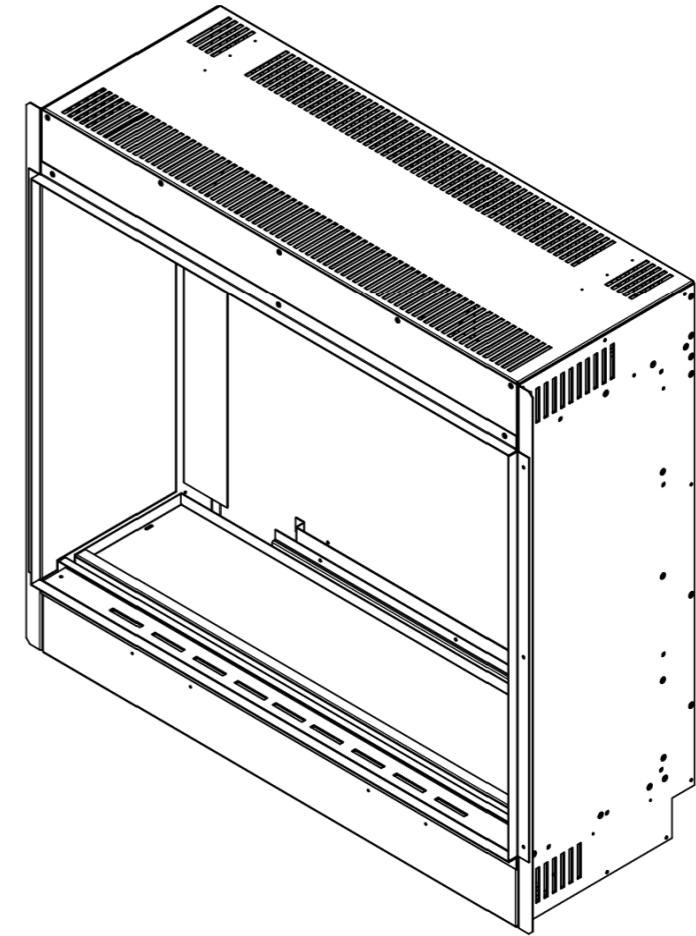
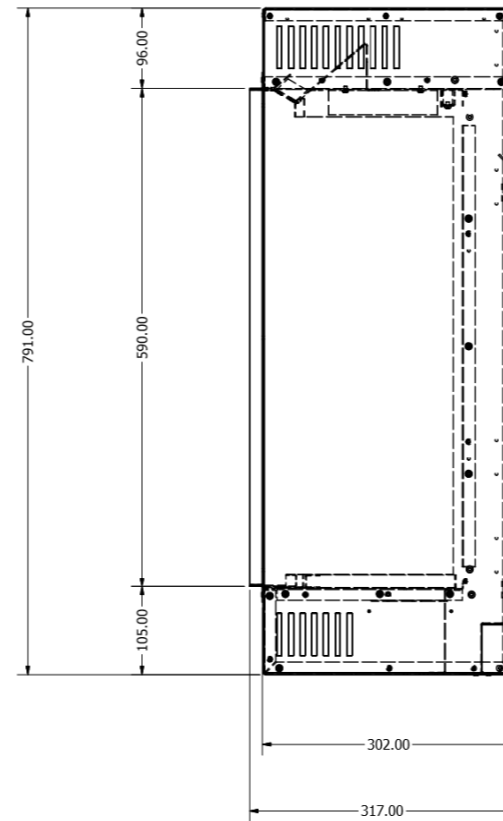
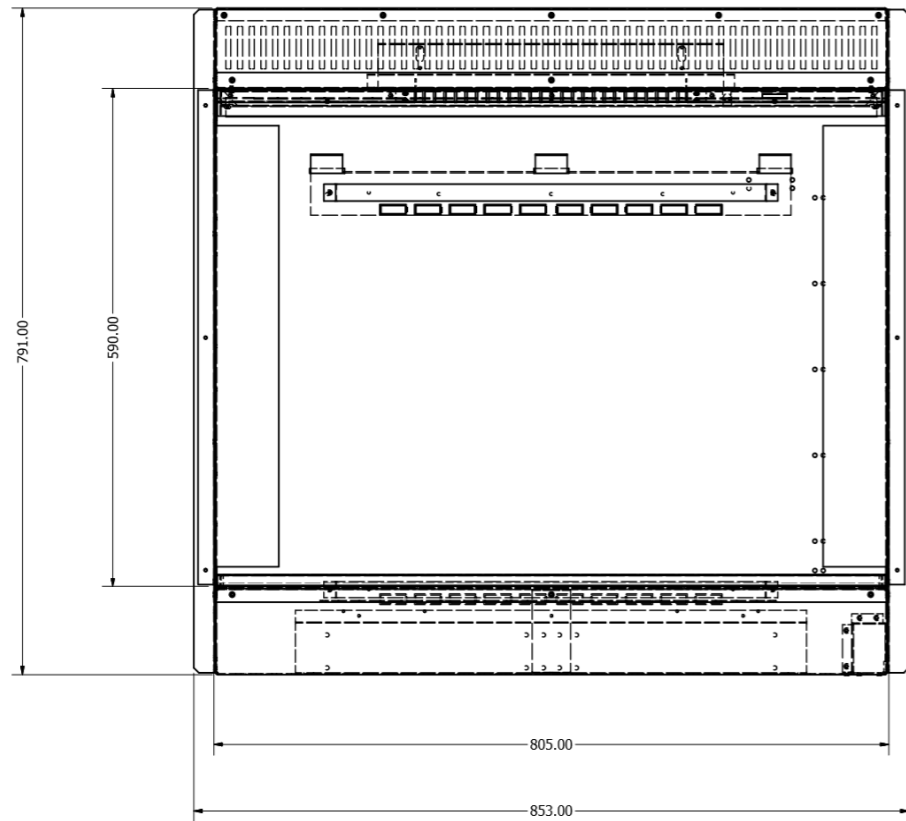
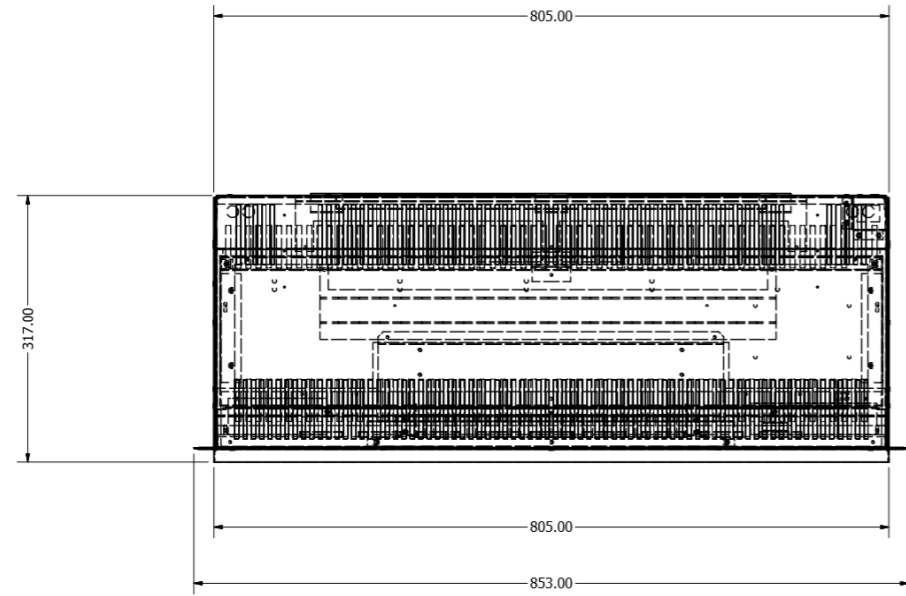

# Motala/E1250

## MOTALA WITH TILE WING

WIDTH - 1668mm

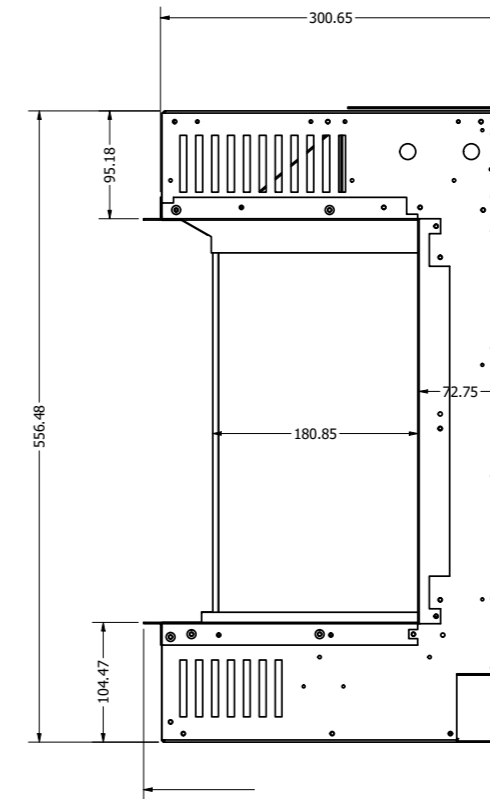
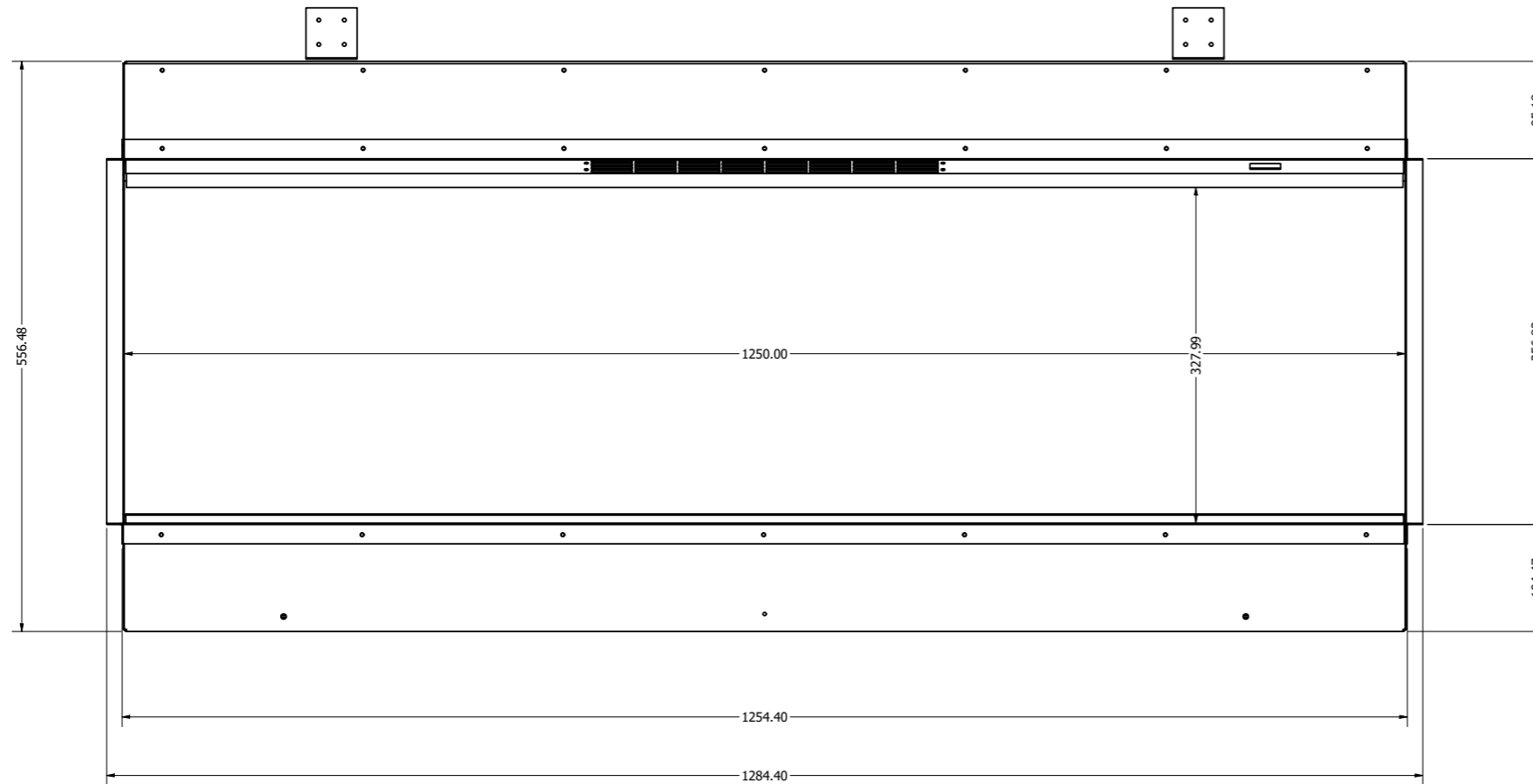
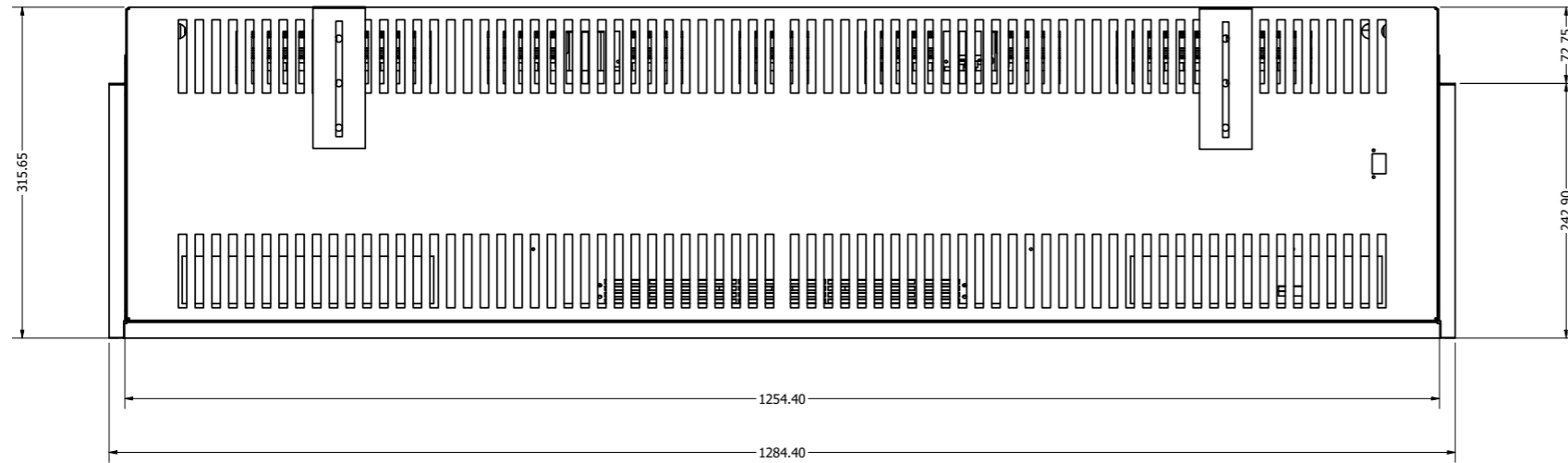

# Newton 10/E1000

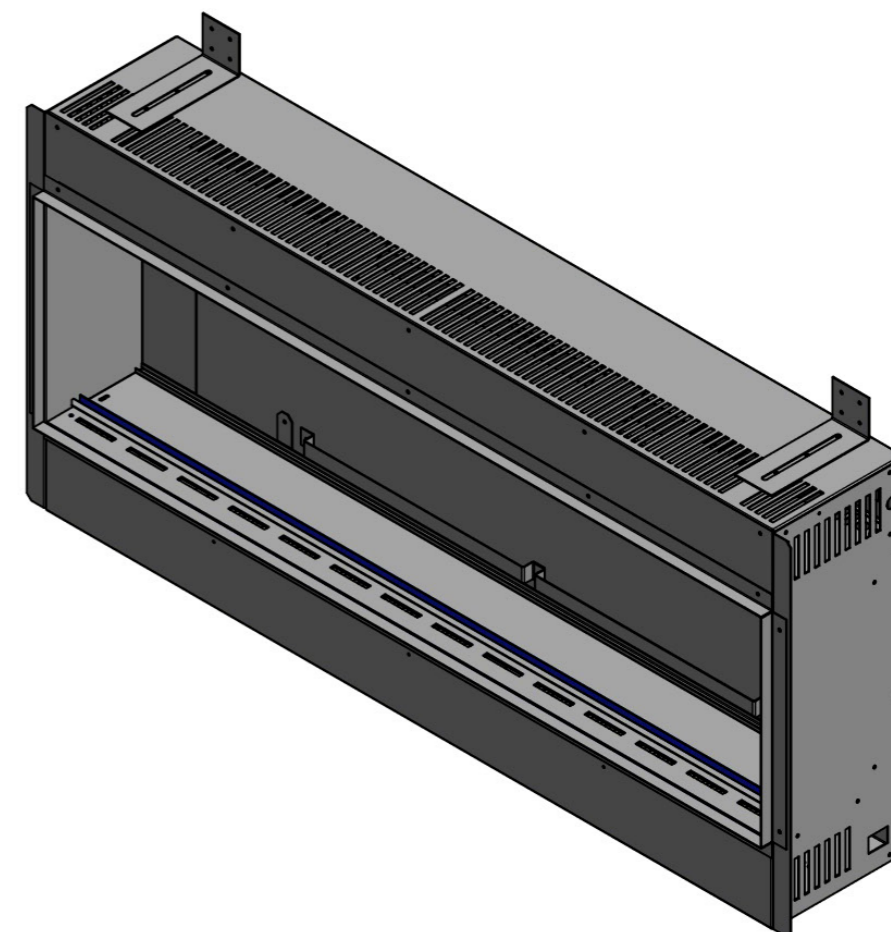
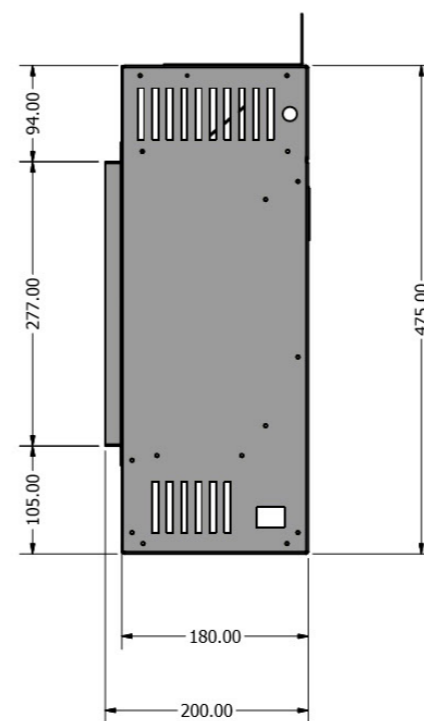
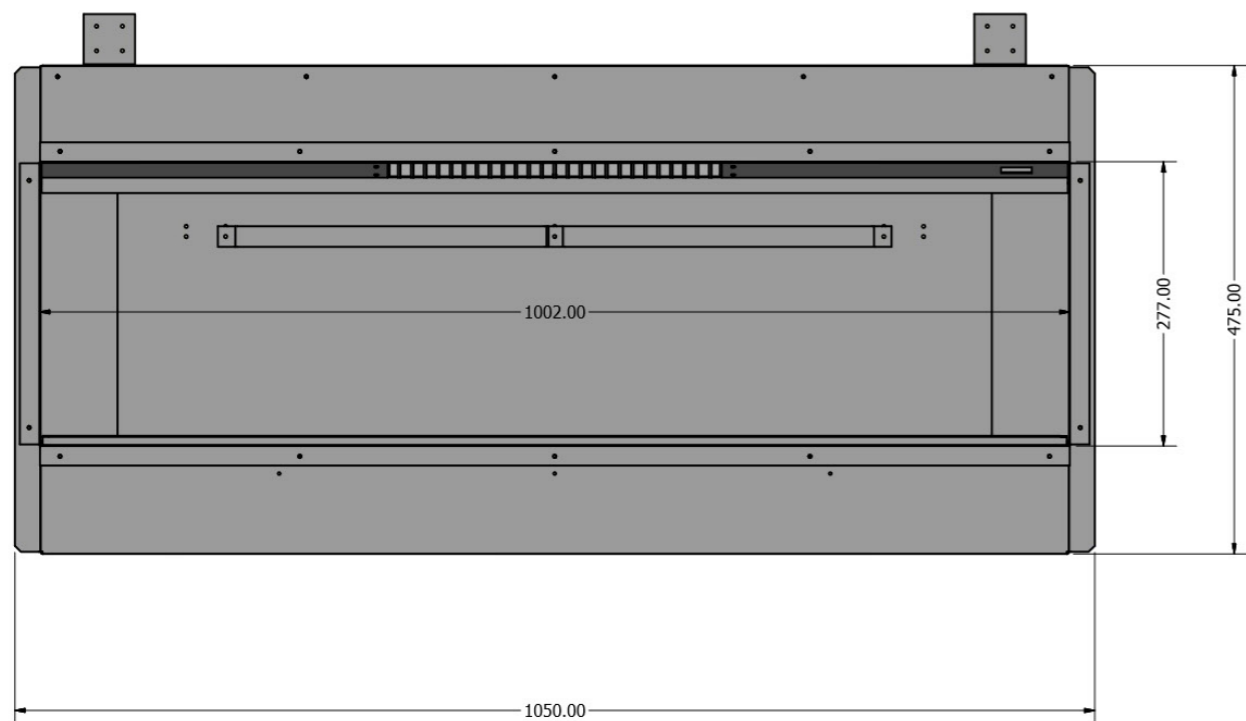
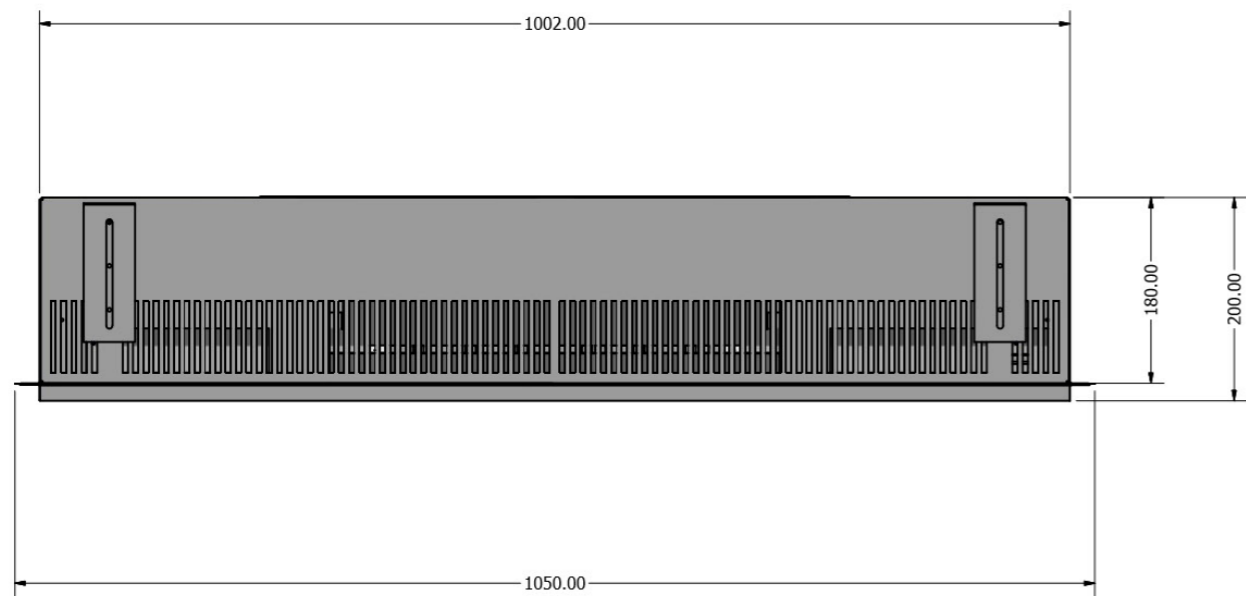

# Newton 9/E900

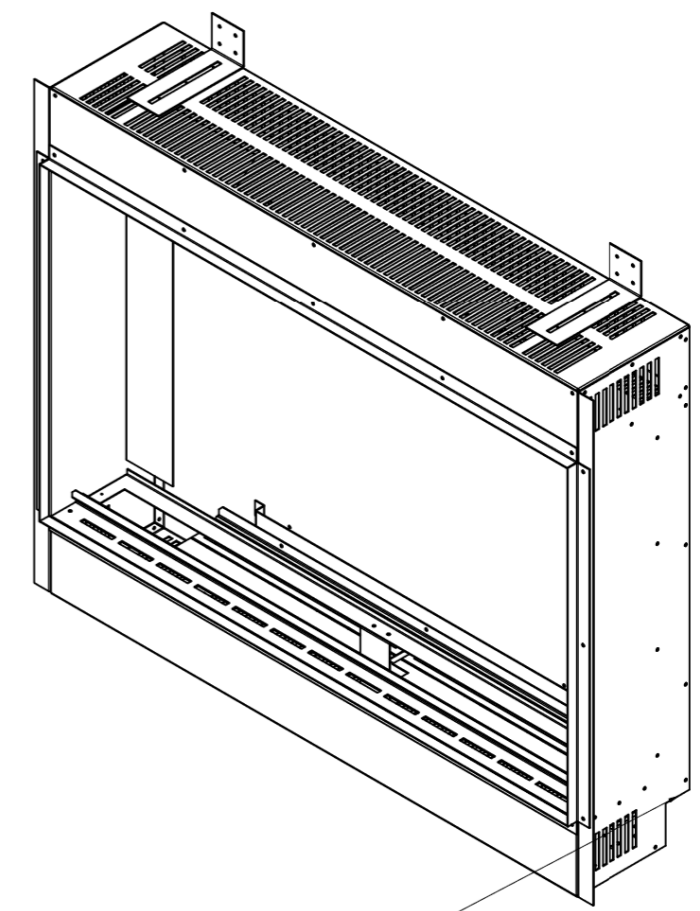
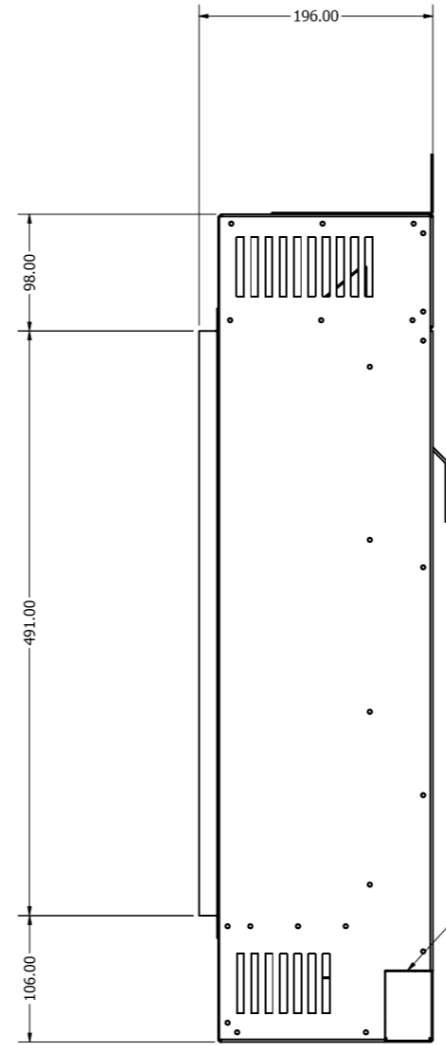
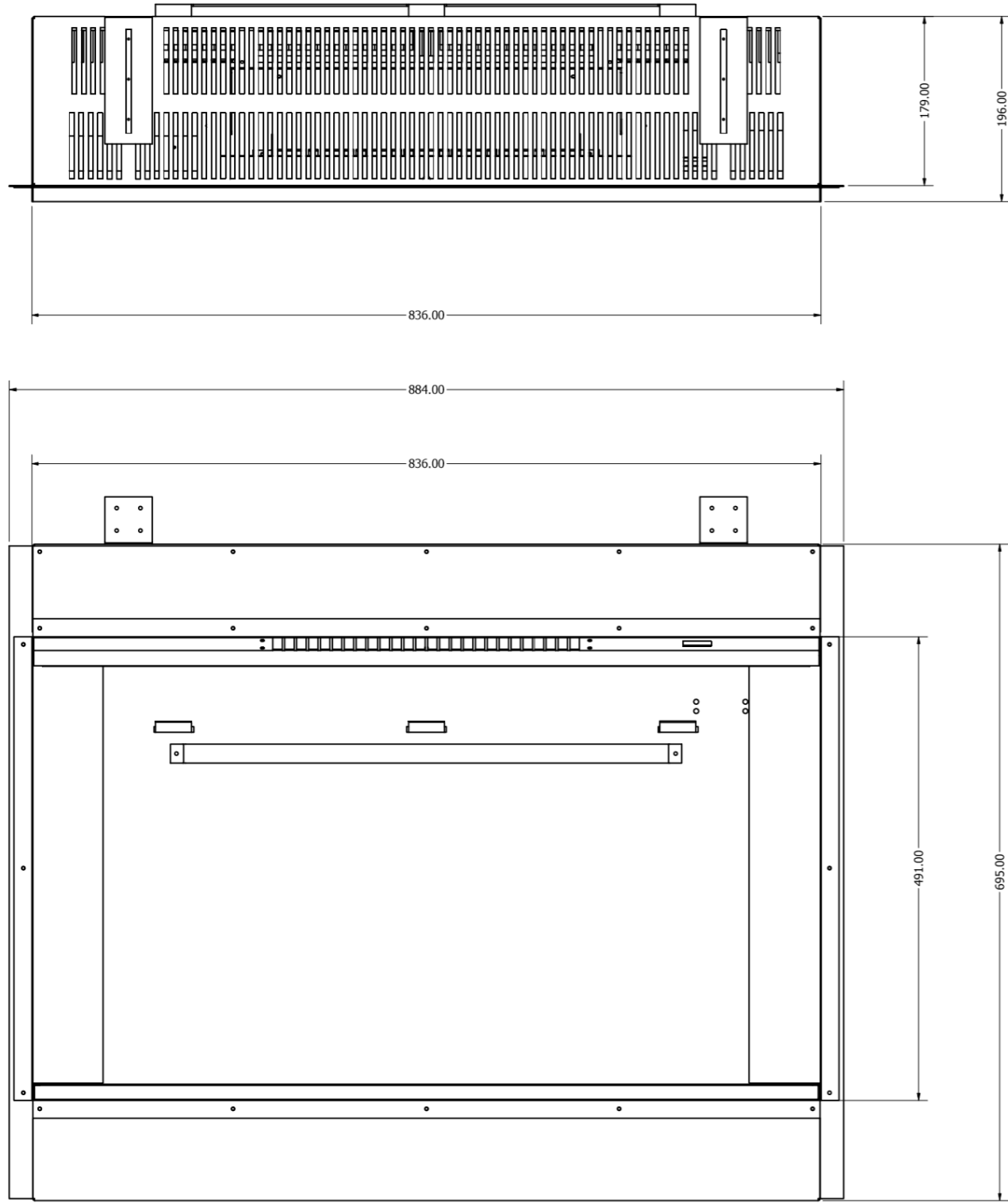

**IEC INLET**

# Newton 7/E700

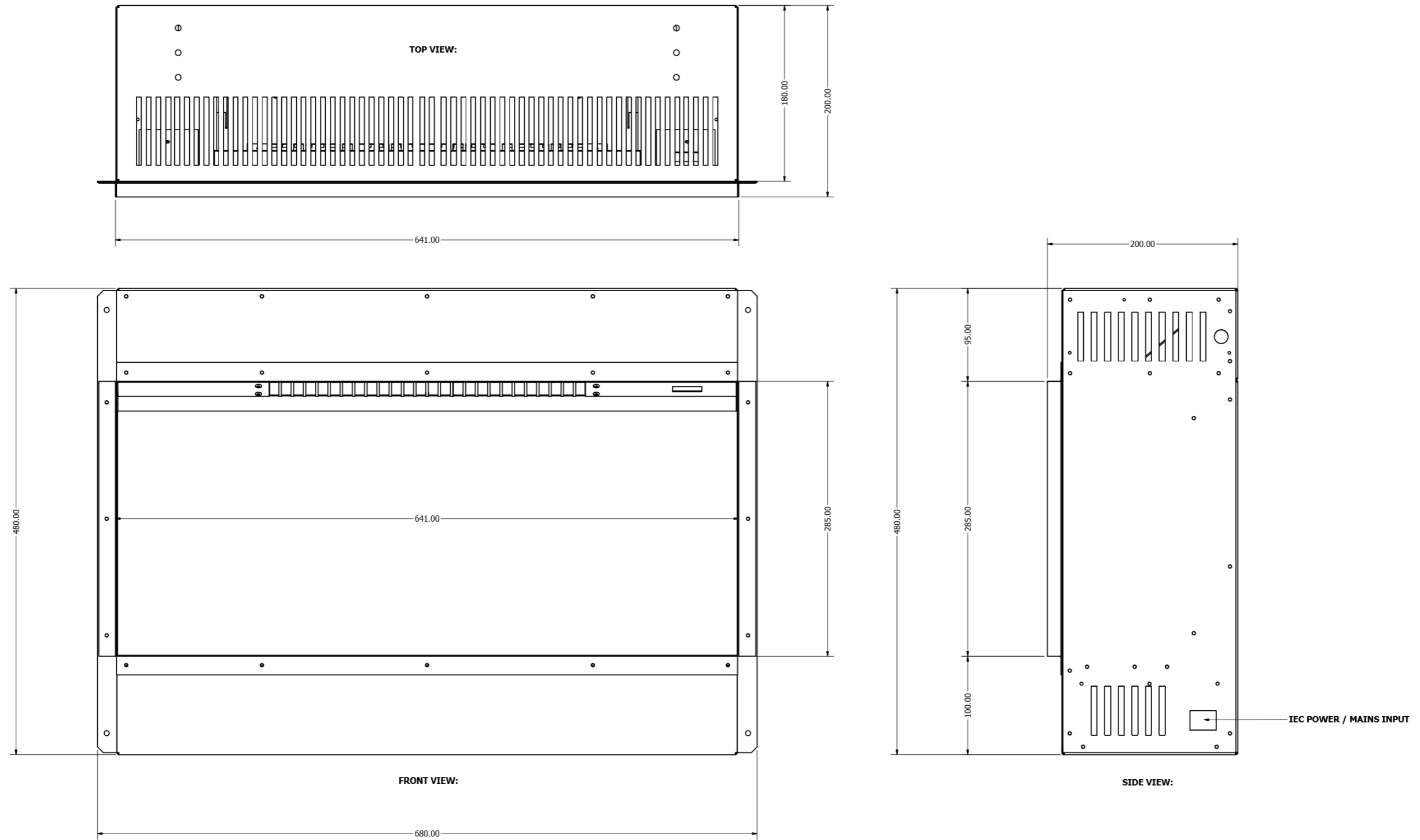

# Newton 6/E600

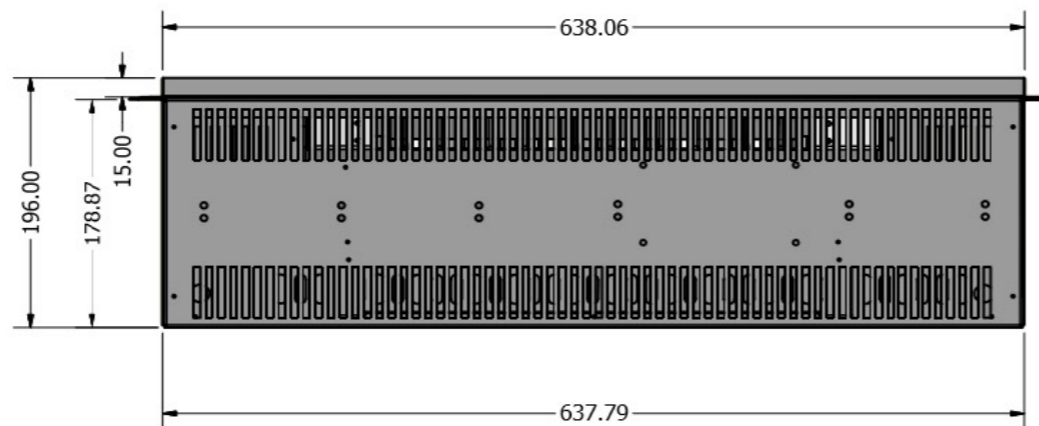
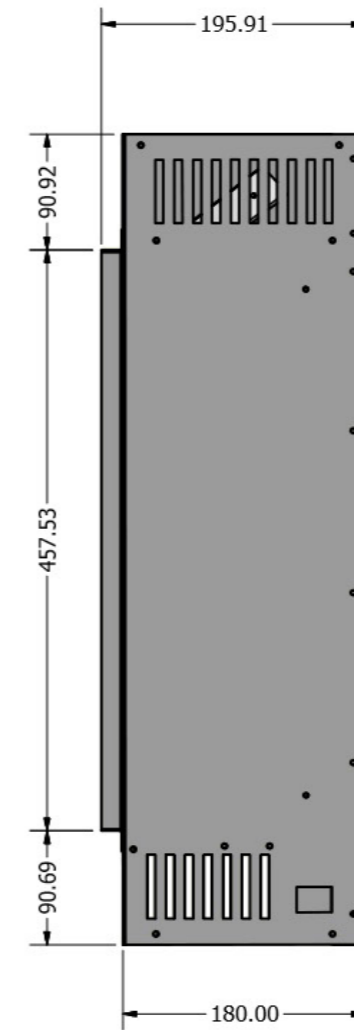
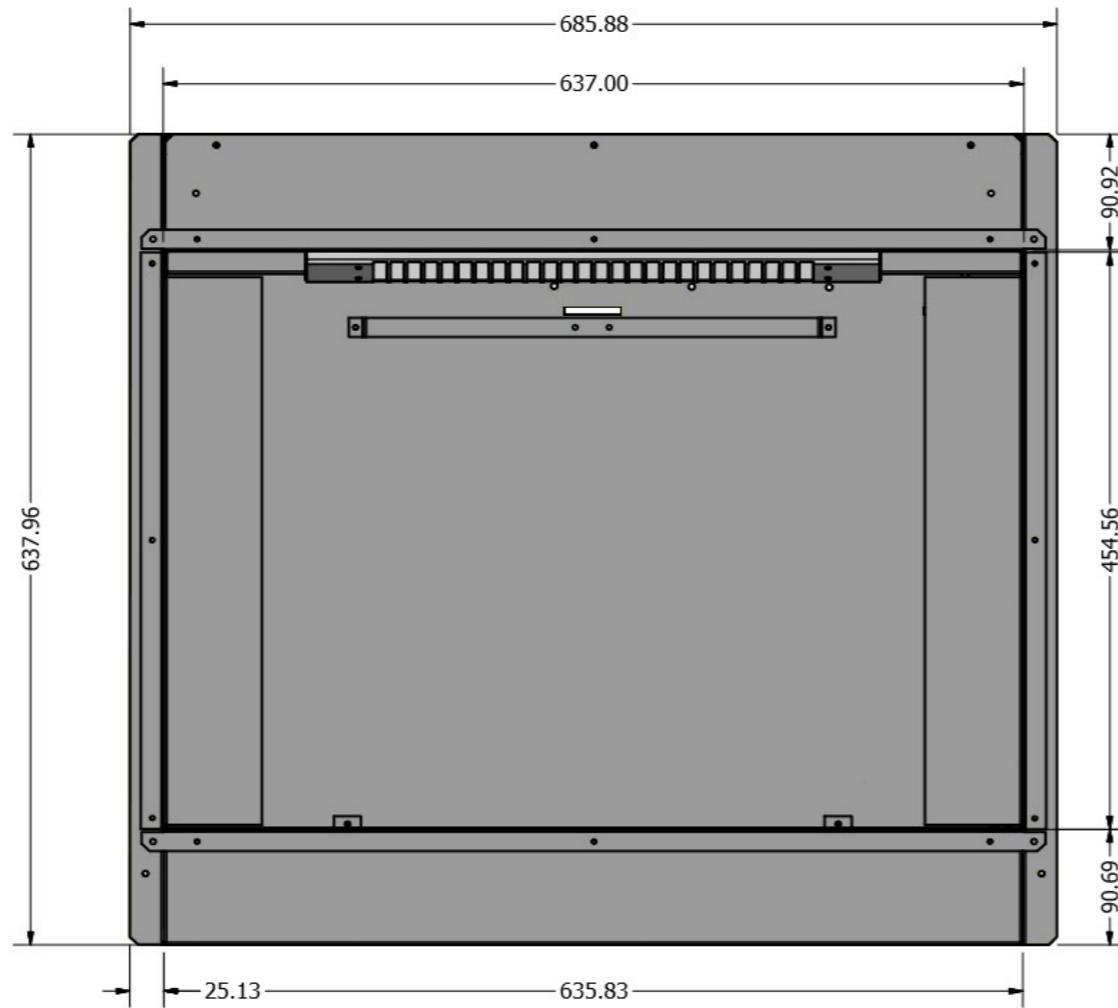

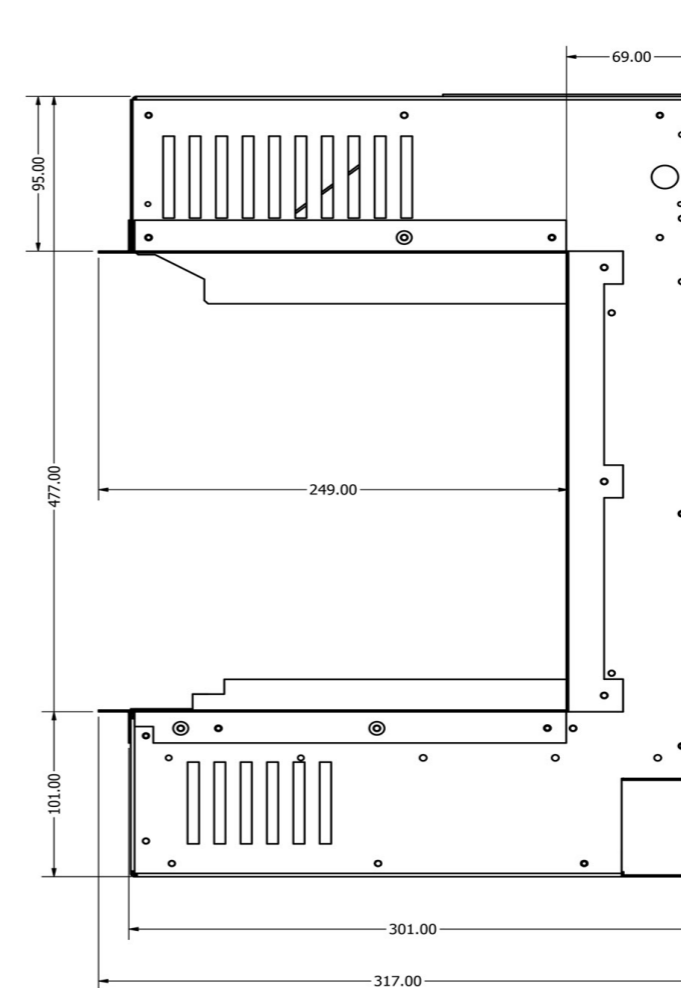
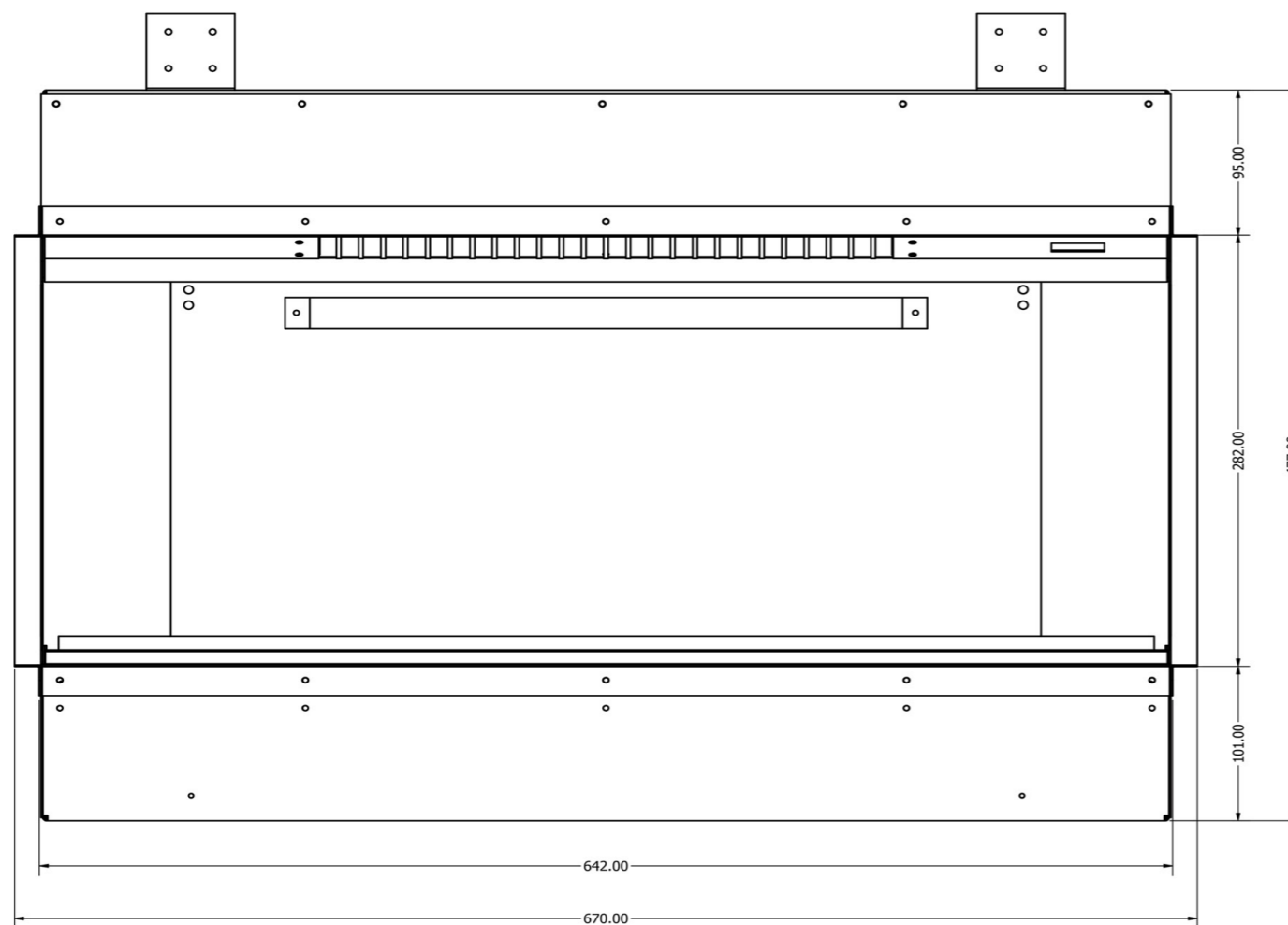
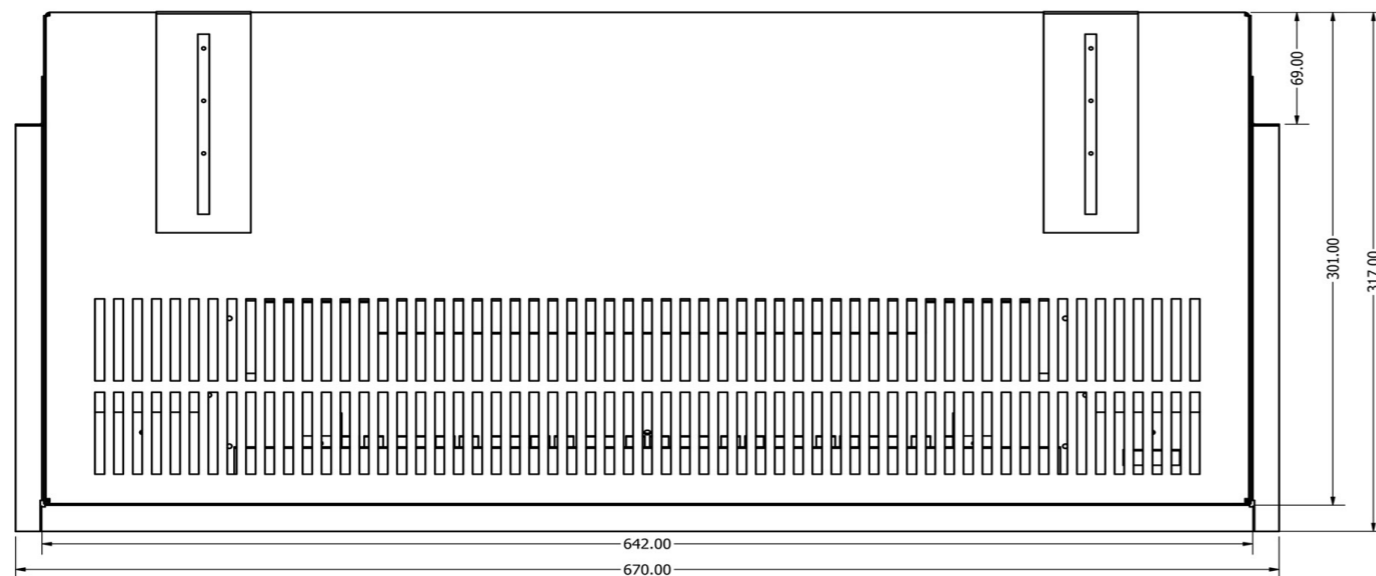

# Thoren/E630

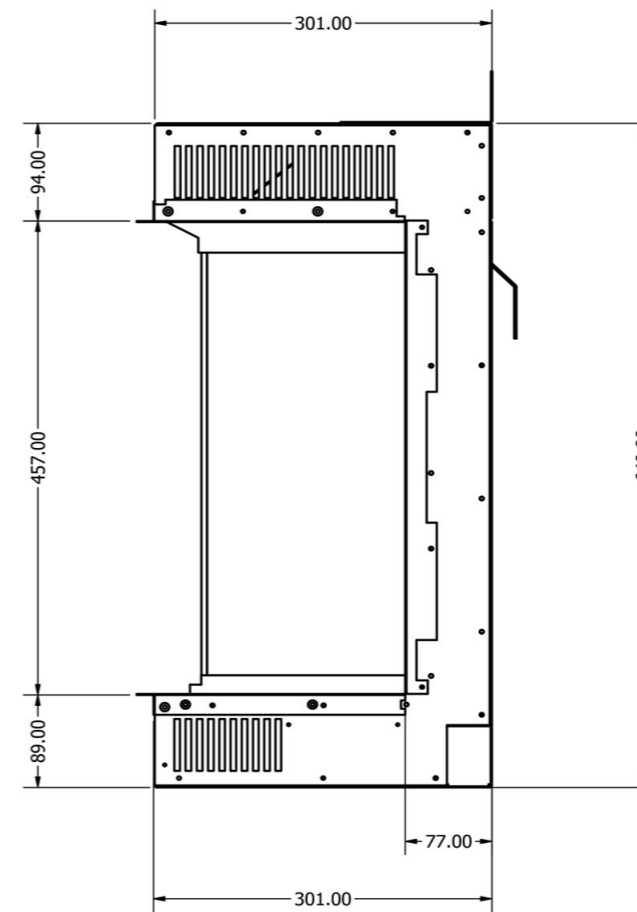
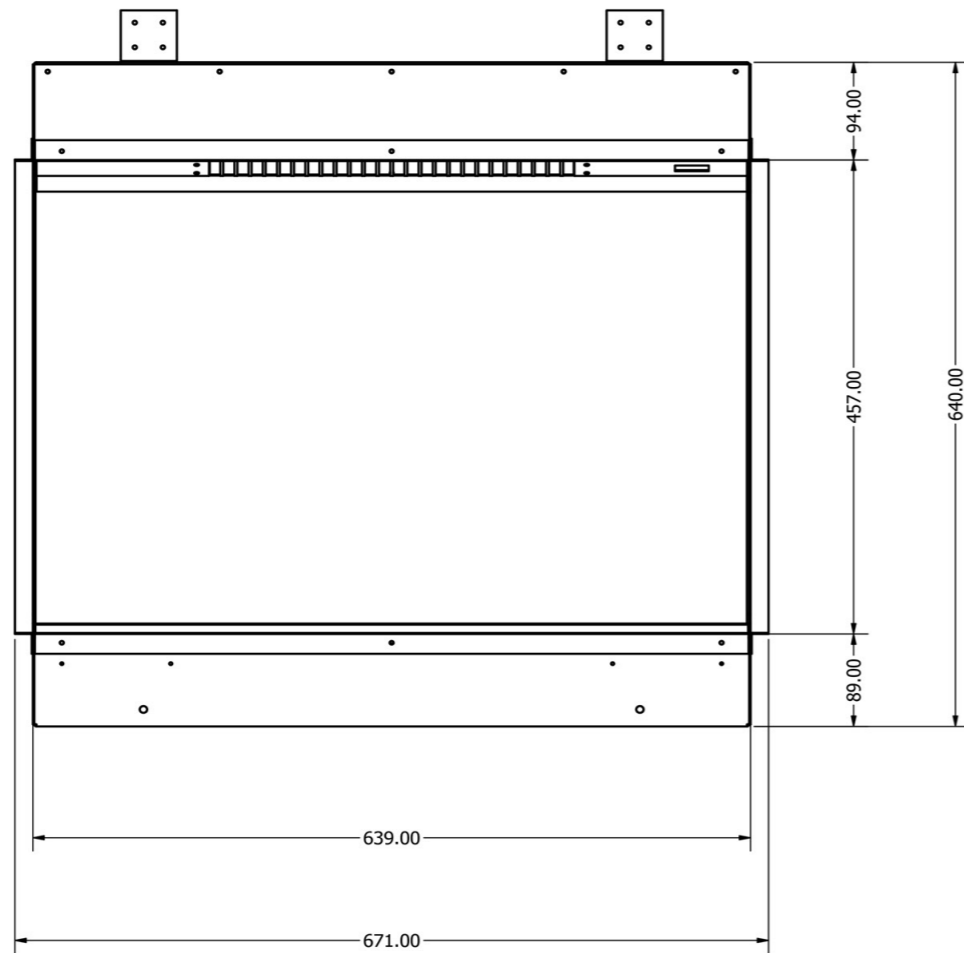
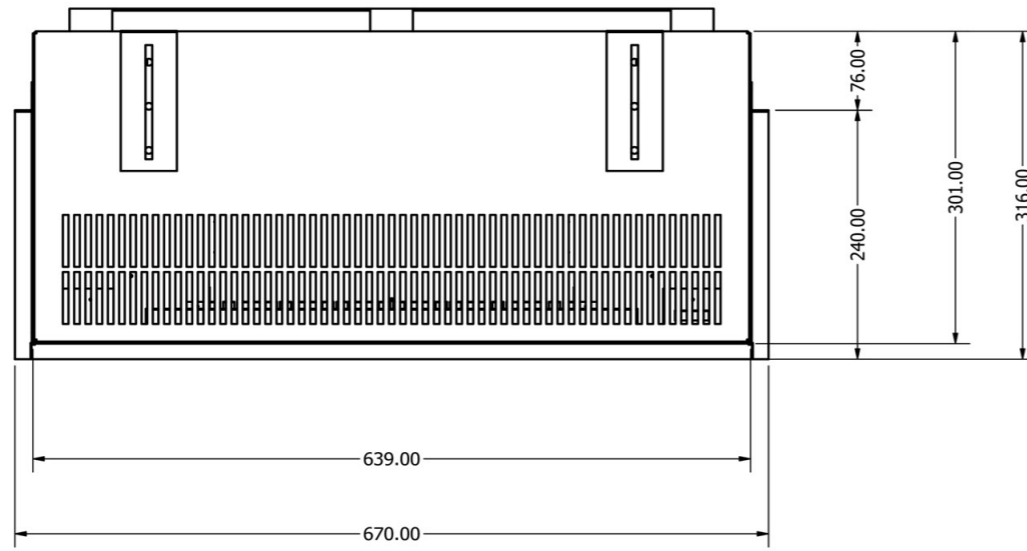



# E1560

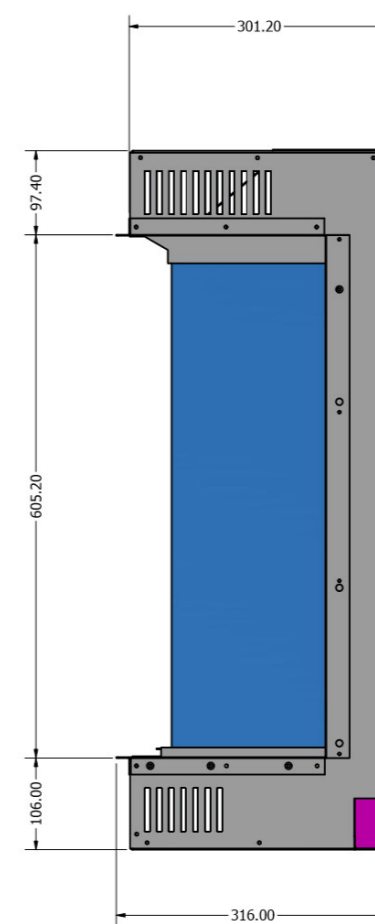
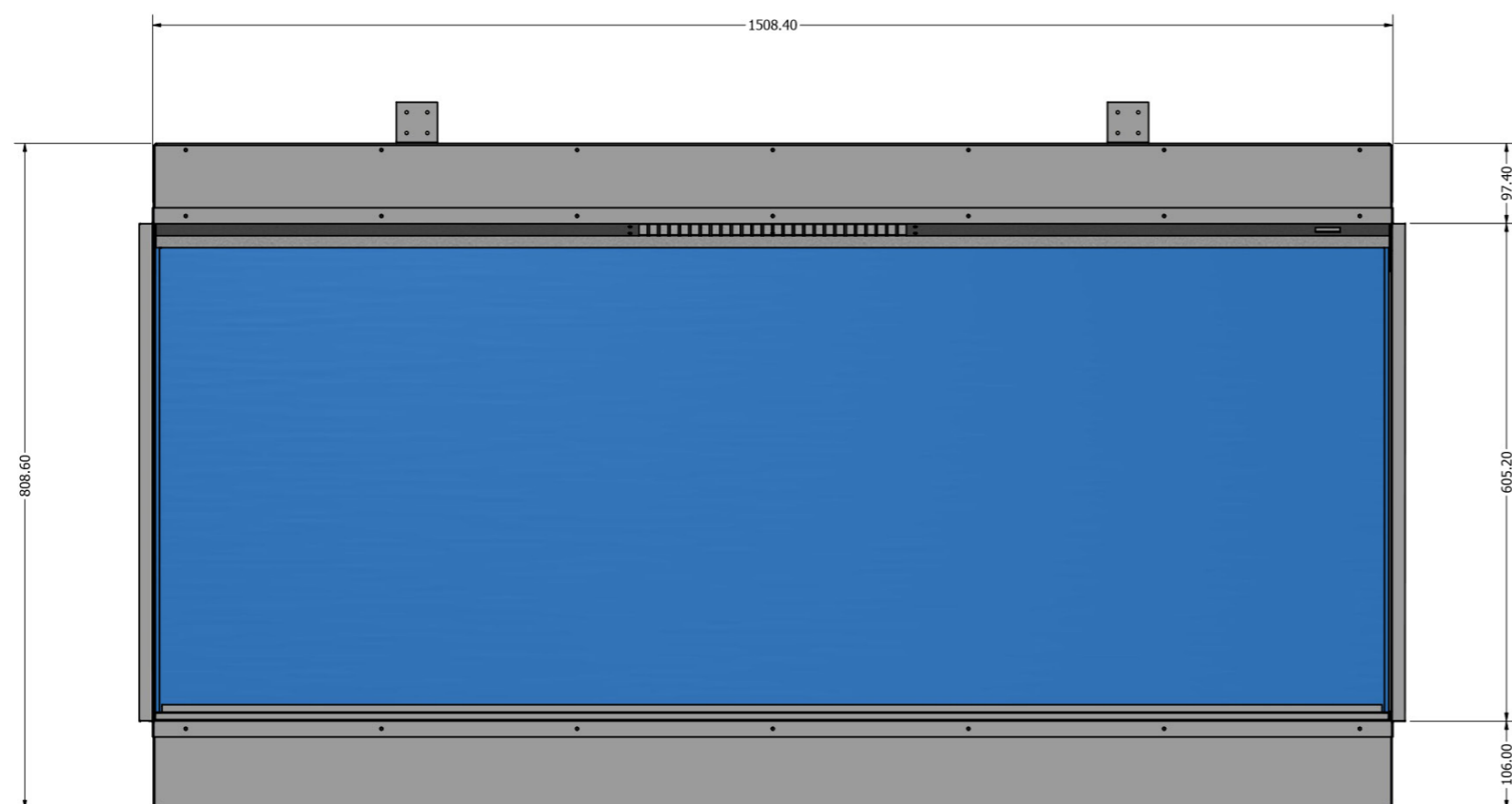
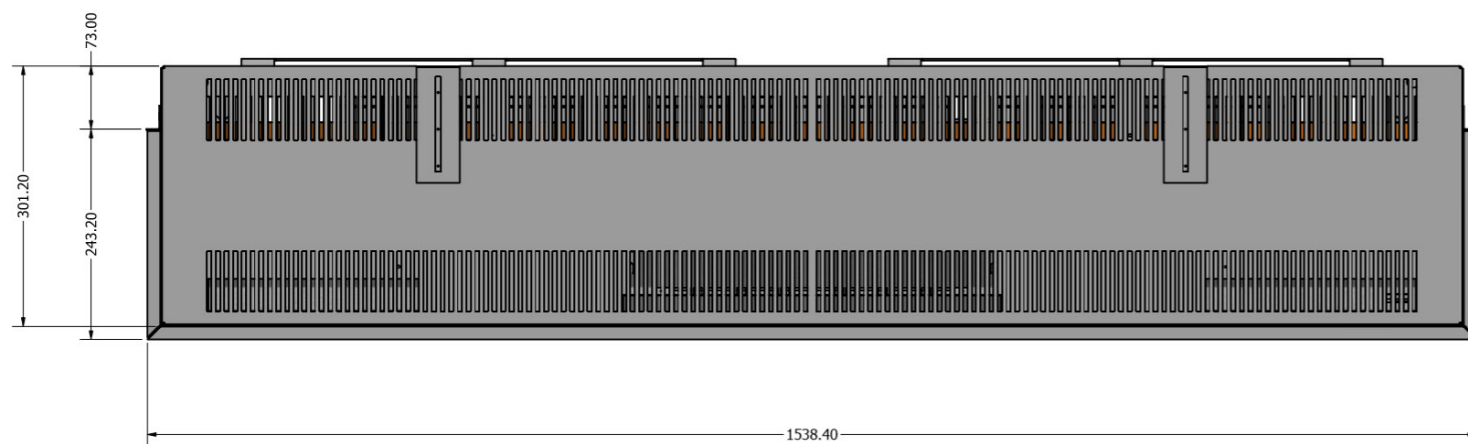

# E810

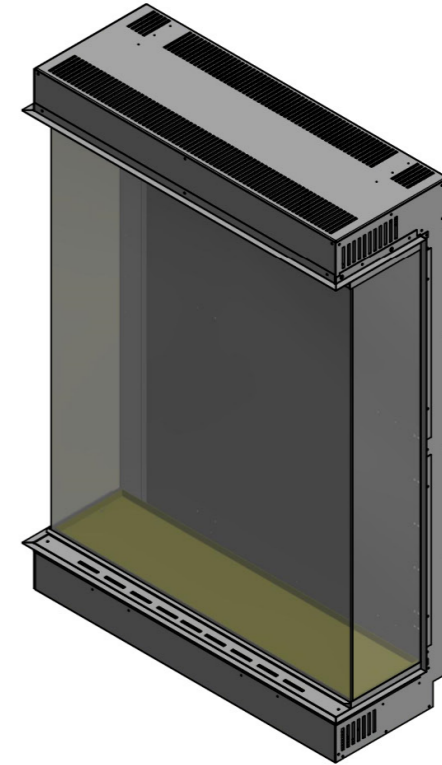
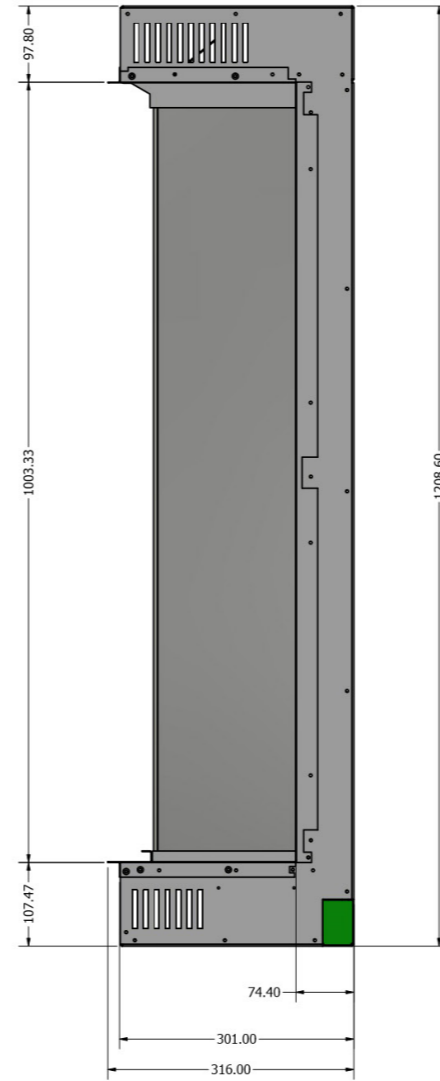
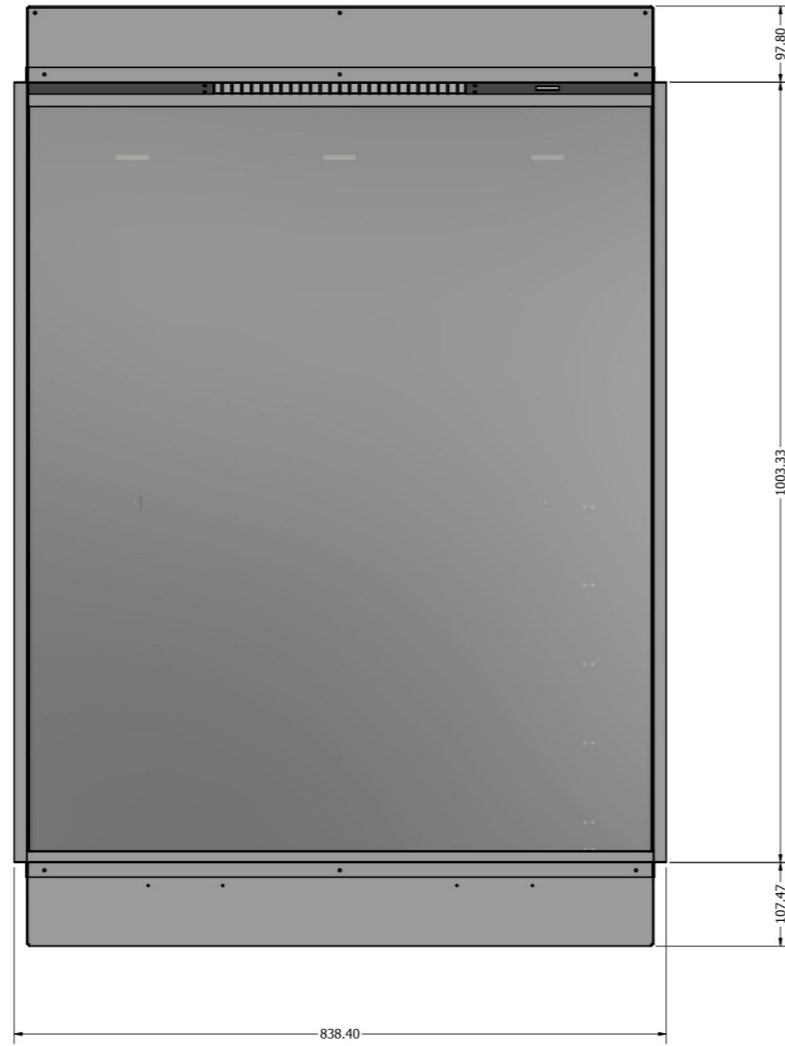
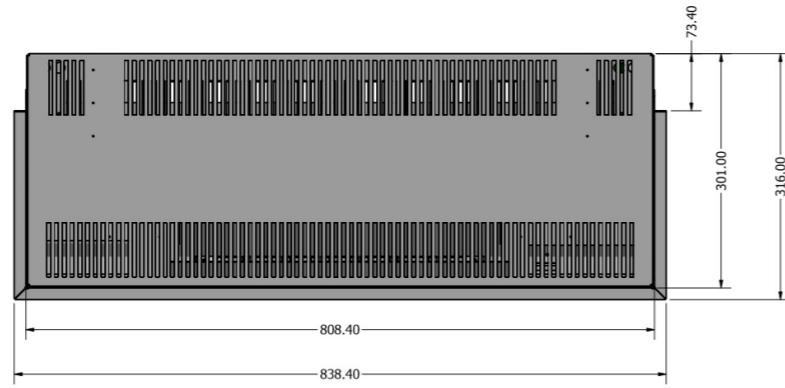

# E810DS

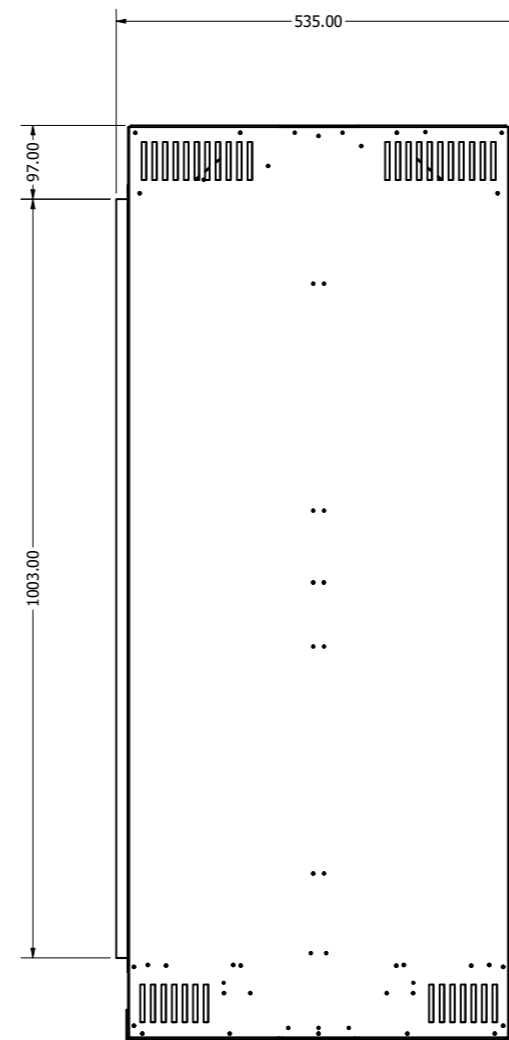
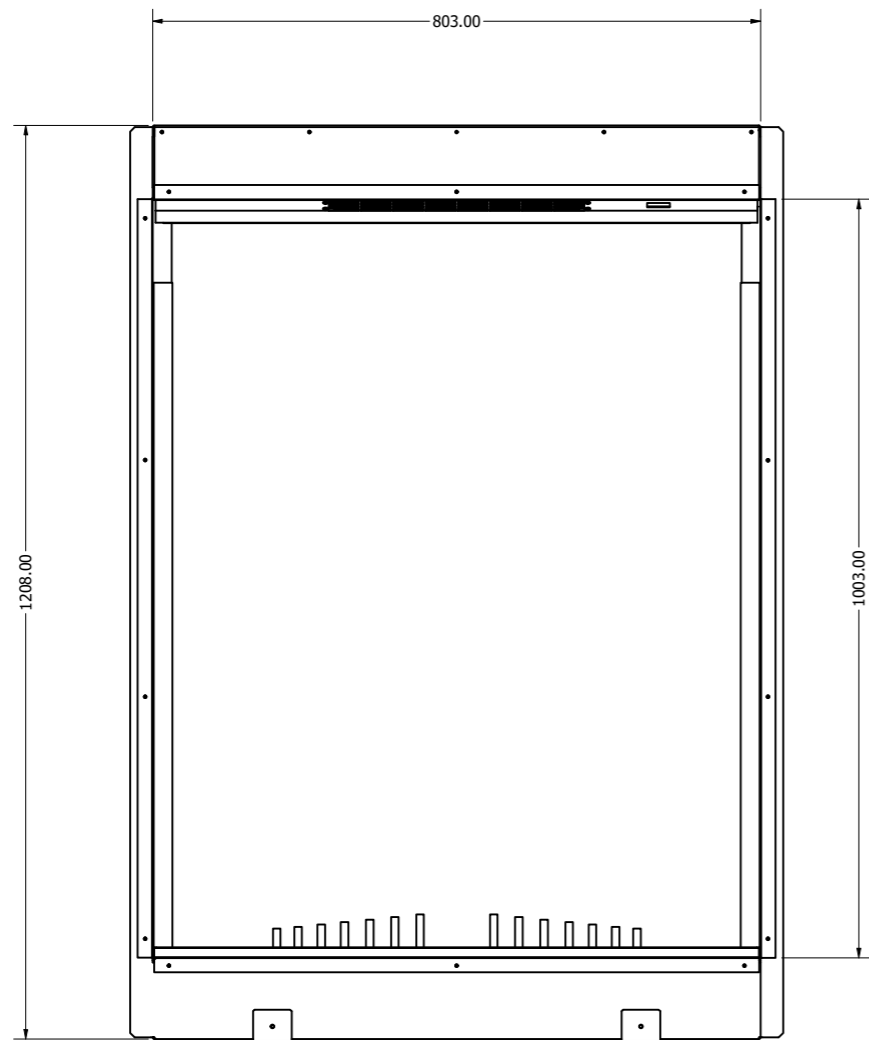
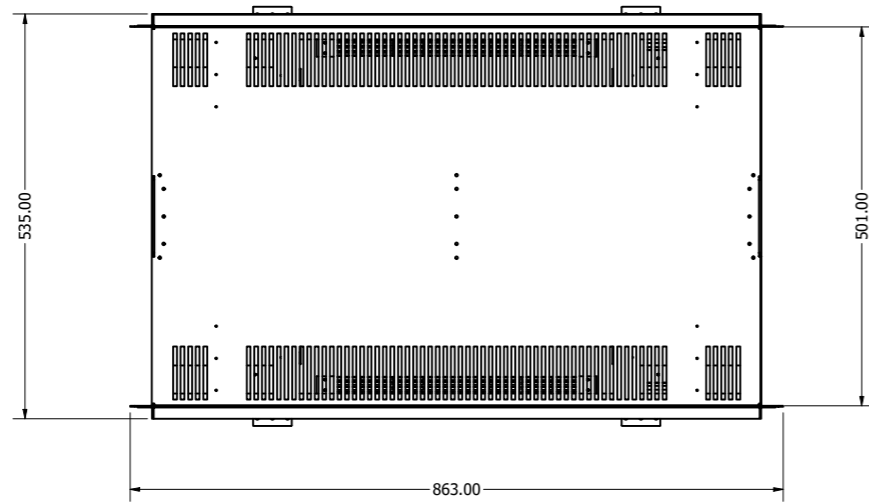

# E500

